

TECHNICAL GUIDE AND PARTS LIST

CAL. Y716A

DIGITAL QUARTZ

CONTENTS

I. SPECIFICATIONS	1
II. DISPLAY FUNCTION	2
III. DISASSEMBLING, REASSEMBLING, LUBRICATING AND CLEANING	3
1. Disassembling, reassembling and lubricating of the case	3
2. Disassembling, reassembling and lubricating of the module	4
3. Cleaning	5
IV. CHECKING AND ADJUSTMENT	7
1. Guide table for checking and adjustment	7
2. Structure of circuit block	8
3. Relationship between the segments (Liquid Crystal Panel electrodes) and C-MOS-LSI output terminals	9
4. Procedure for checking and adjustment	10
A. Check battery voltage	10
B. Check battery conductivity	10
C. Check current consumption	10
D. Check water resistance	11
E. Check contact of C-MOS-LSI ~ liquid crystal panel	11
F. Check liquid crystal panel and circuit block	12
G. Check accuracy	13
H. Check functioning and adjustment	13
I. Check conductivity of switch components	13
J. Check alarm function	14
VI. PARTS LIST	15

I. SPECIFICATIONS

Item	Cal. No.	Y716A			
Display medium		Nematic Liquid Crystal, FEM (Field Effect Mode)			
Liquid crystal panel		Multiplex driving system			
Display system		<ul style="list-style-type: none"> ● Time display ● Timer display ● Alarm time display ● Arbitrary timer display ● Time setting display 			
Additional mechanism		<ul style="list-style-type: none"> ● Illuminating light ● Alarm test function ● Hourly time signal ● Timer function 			
		<table border="1"> <thead> <tr> <th>Fixed timer</th> <th>Arbitrary timer</th> </tr> </thead> <tbody> <tr> <td>5 min. 15 min. 30 min. 45 min. 60 min.</td> <td>99 min.</td> </tr> </tbody> </table>	Fixed timer	Arbitrary timer	5 min. 15 min. 30 min. 45 min. 60 min.
Fixed timer	Arbitrary timer				
5 min. 15 min. 30 min. 45 min. 60 min.	99 min.				
		<ul style="list-style-type: none"> ● Pattern segment checking mode ● System reset function 			
Loss/gain		Loss/gain at normal temperature range Monthly rate: Less than 15 seconds			
Casing diameter		24.7 mm (between 3 o'clock and 9 o'clock sides) 24.3 mm (between 6 o'clock and 12 o'clock sides)			
Height		5.1 mm			
Regulation system		Trimmer condenser			
Measuring gate by quartz tester		Any gate is available			
Battery		Lithium battery MAXELL CR2016, MATSUSHITA BR2016 or SANYO CR2016 Voltage: 3.0V Battery life: Approx. 3 years			

II. DISPLAY FUNCTION

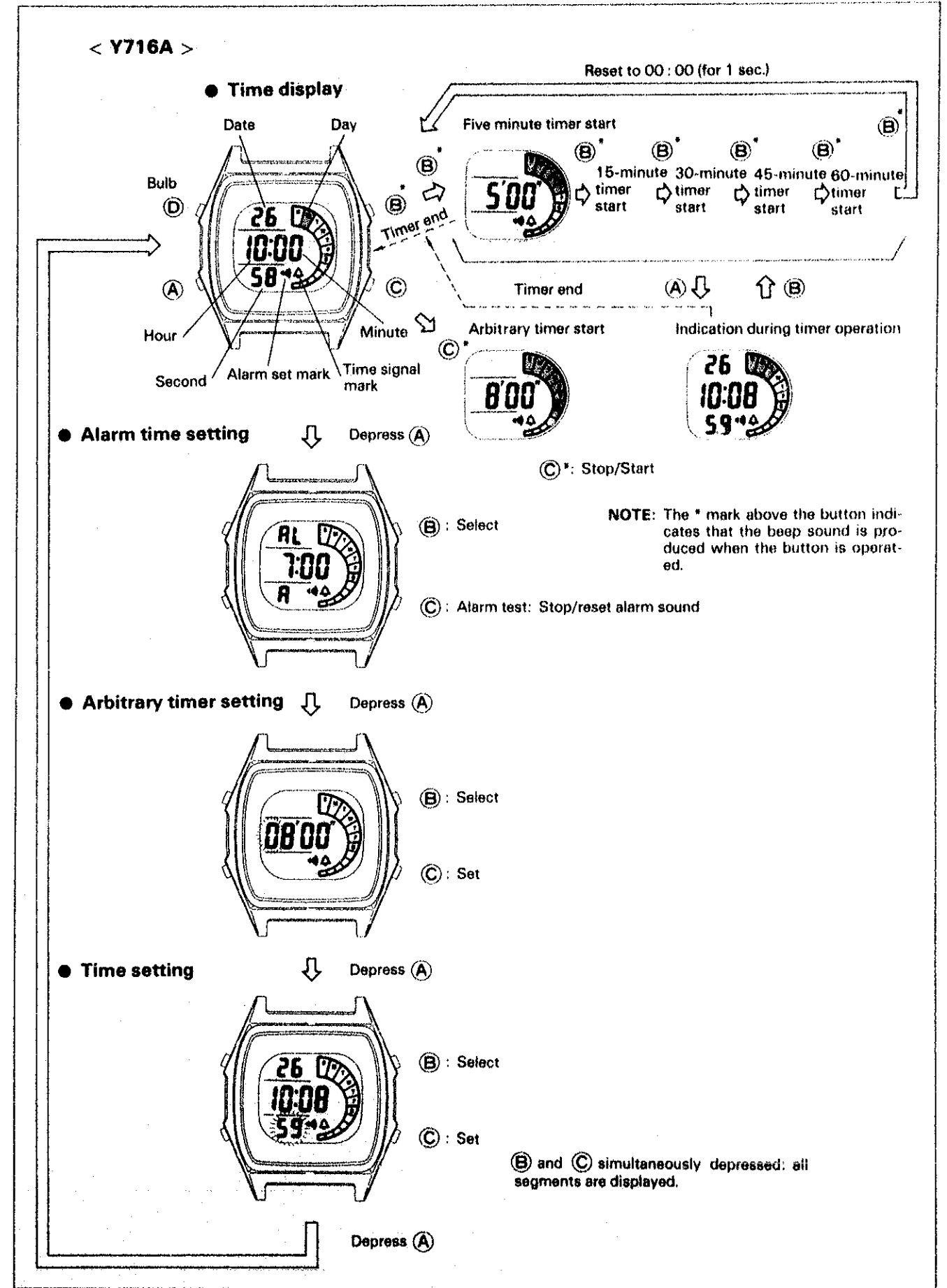

III. DISASSEMBLING, REASSEMBLING, LUBRICATING, AND CLEANING

1. Disassembling, reassembling and lubricating of the case

- Disassembling procedures: ① ~ ⑤
- Reassembling procedures: ⑤ ~ ①

Lubricating:

- Silicone grease

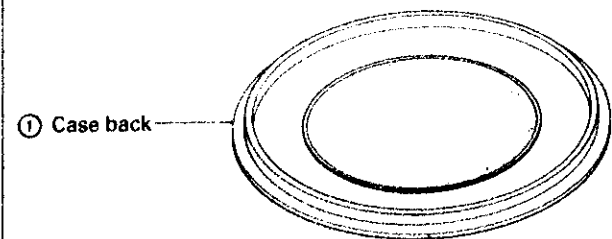
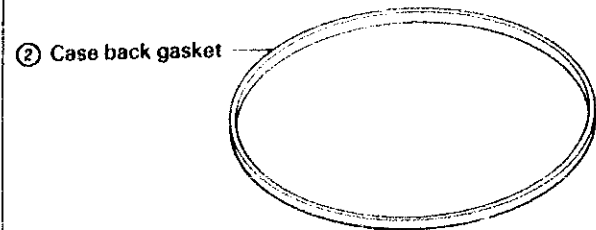
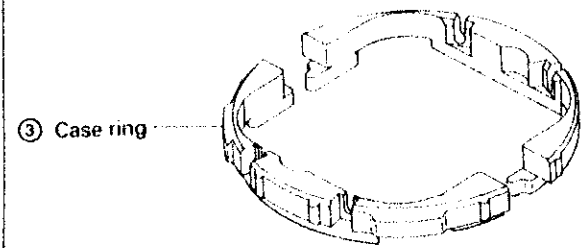
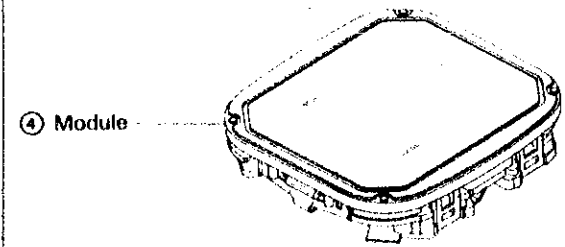
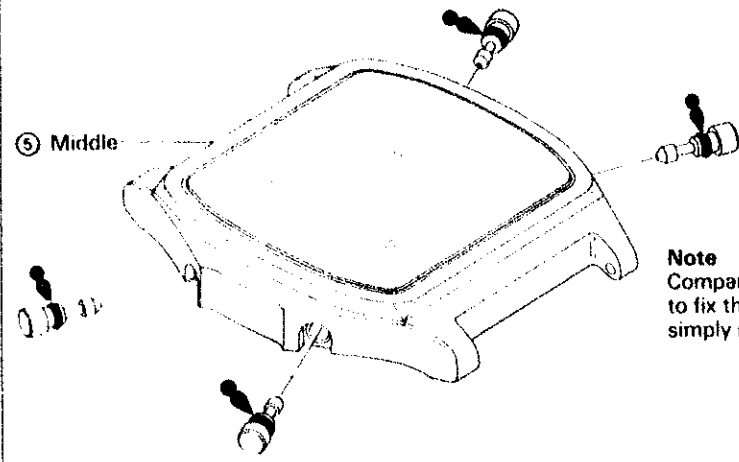

Note
Compared with the structure in which a retaining ring is used to fix the button, two case rings serve to retain the button. By simply removing the case ring, the button can be removed.

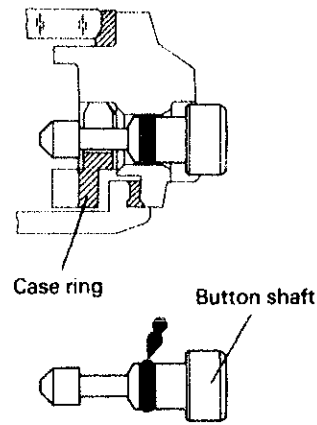

Notes on disassembly/reassembly

- To remove the module, remove the case ring and pull out the buttons.
- To remove/replace the case ring, slightly depress the buttons.

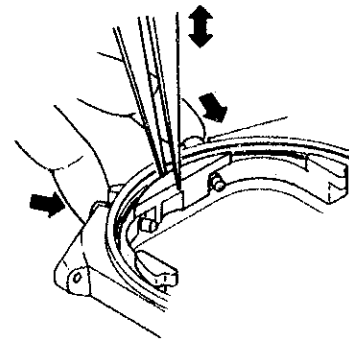

2. Disassembling and reassembling of the module

- Disassembling procedures: ① ~ ⑨
- Reassembling procedures: ⑨ ~ ①

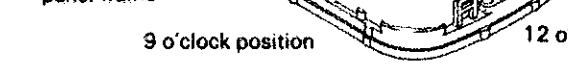
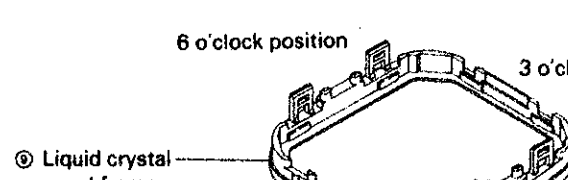
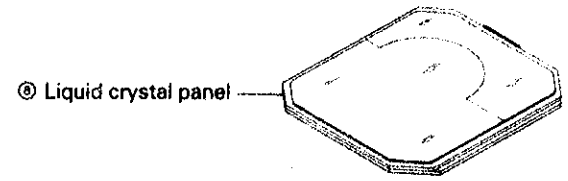
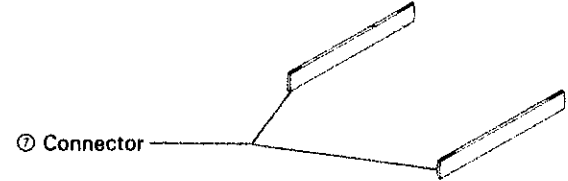
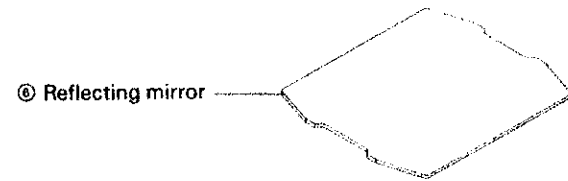
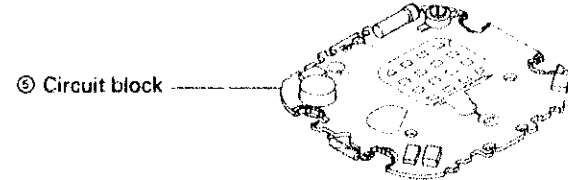
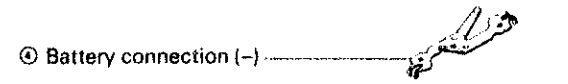
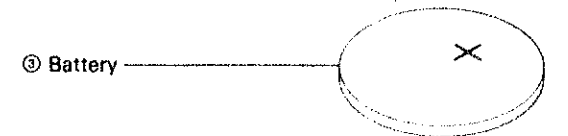
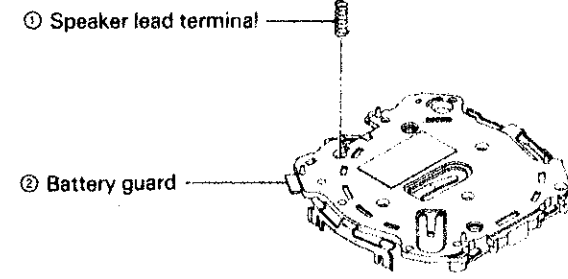

Notes on disassembly

- This watch does not use any screws for battery retaining. The claws of the panel frame engage with the notch of the battery clamp. To disassemble, insert tweezers at the 4 points indicated by the arrow and prise open.

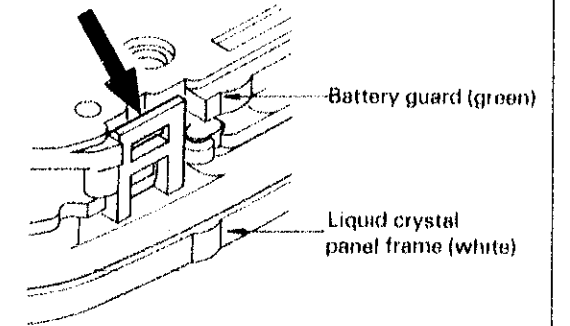

Notes on battery guard assembly

- Hook switch spring of the battery guard with the switch pattern (conductive portion to switch spring) of the circuit block as illustrated below.

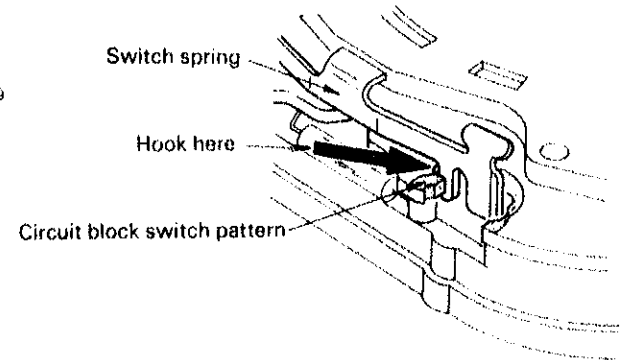

Notes on assembly

- The shape of the panel frame differs in the 3 o'clock and 9 o'clock sides. Assemble the panel frame referring to the illustration.

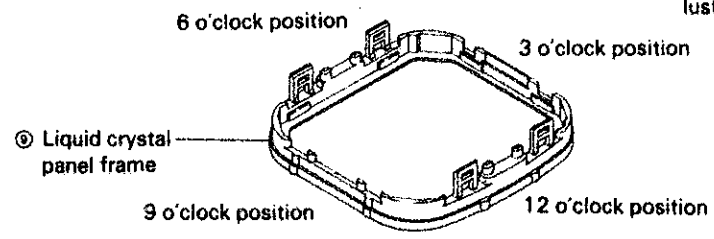

2. Disassembling and reassembling of the module

Disassembling procedures Figs.: ① ~ ⑧

Reassembling procedures Figs.: ⑧ ~ ①

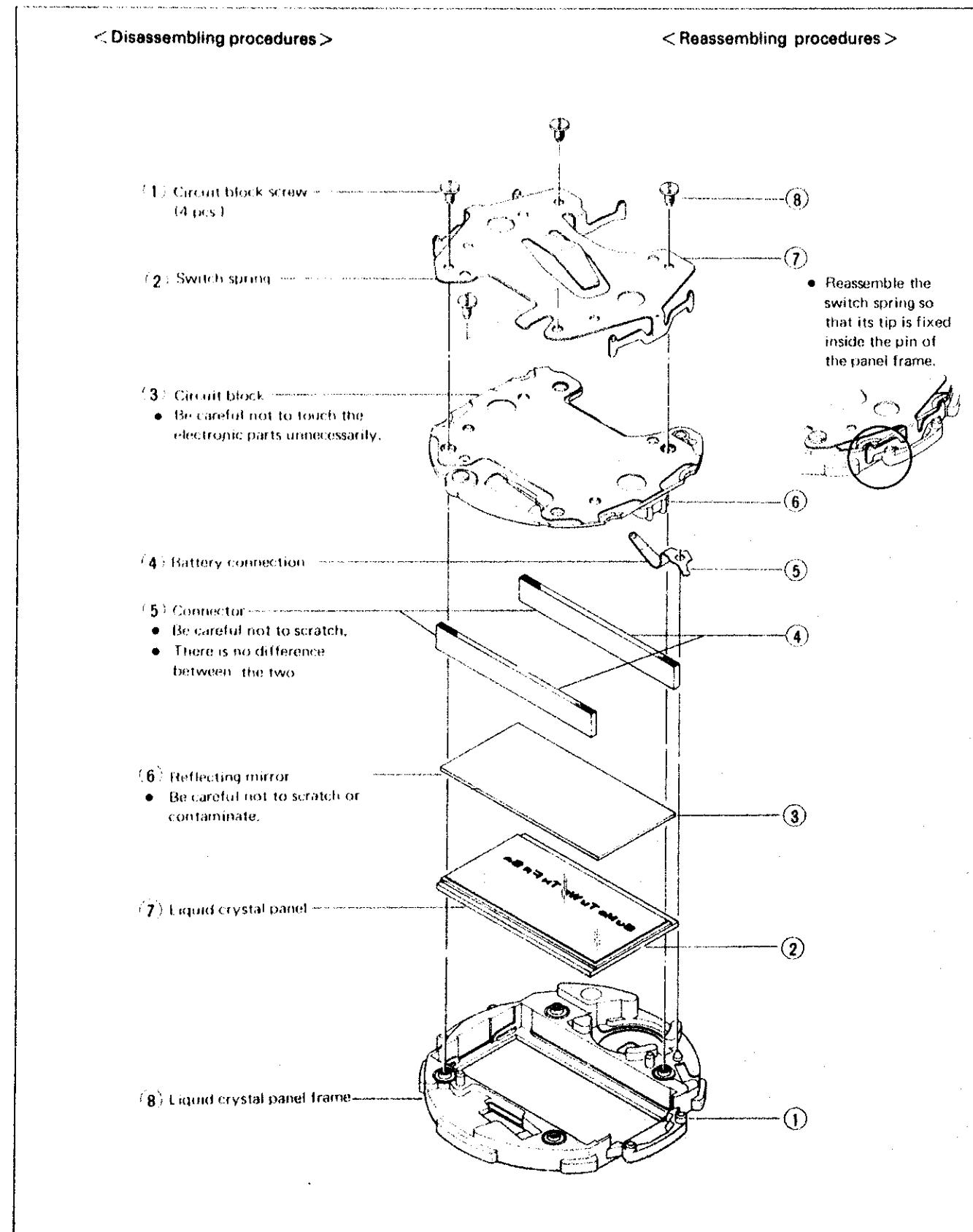

IV. CHECKING AND ADJUSTMENT

1. Guide table for checking and adjustment

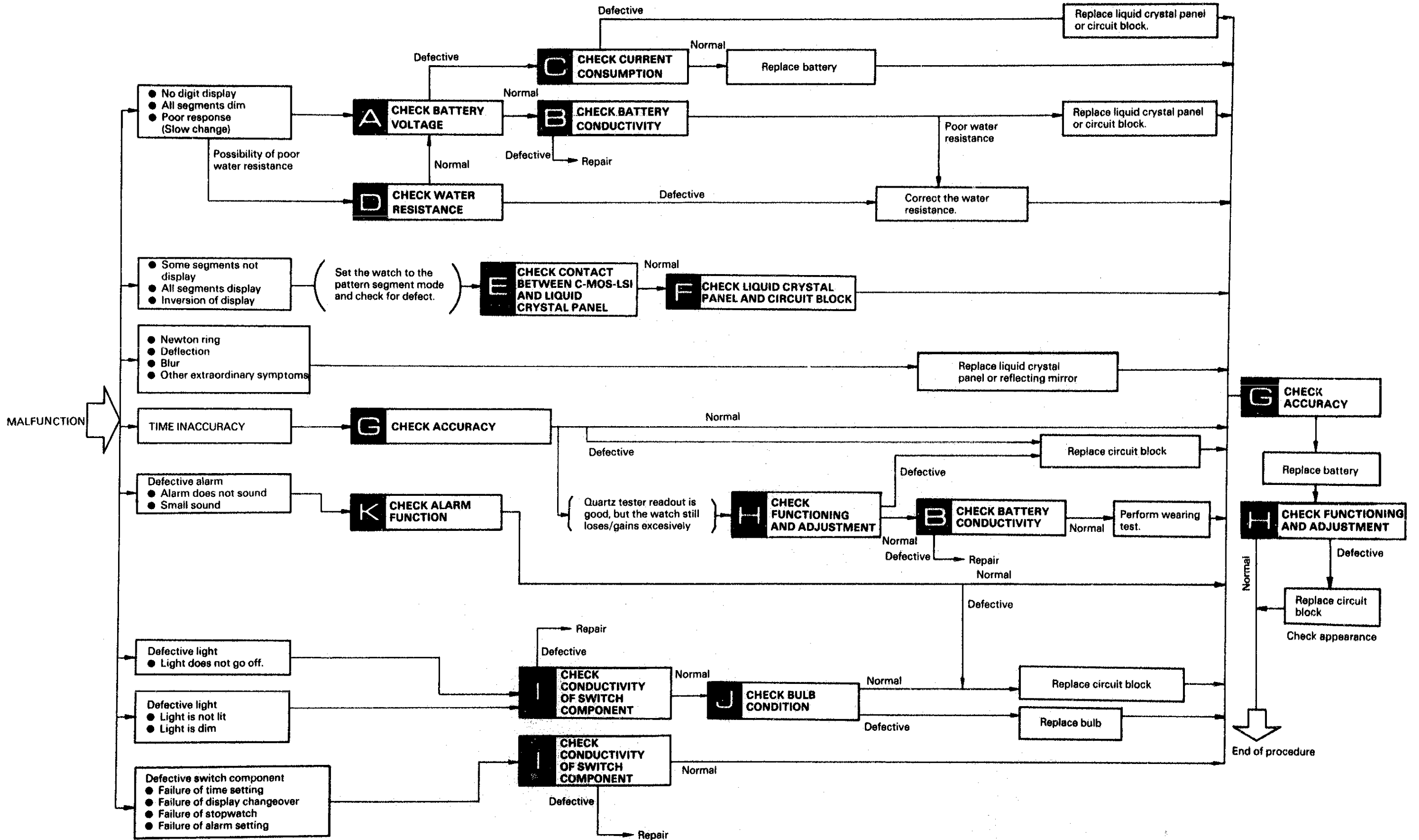

2. Structure of circuit block

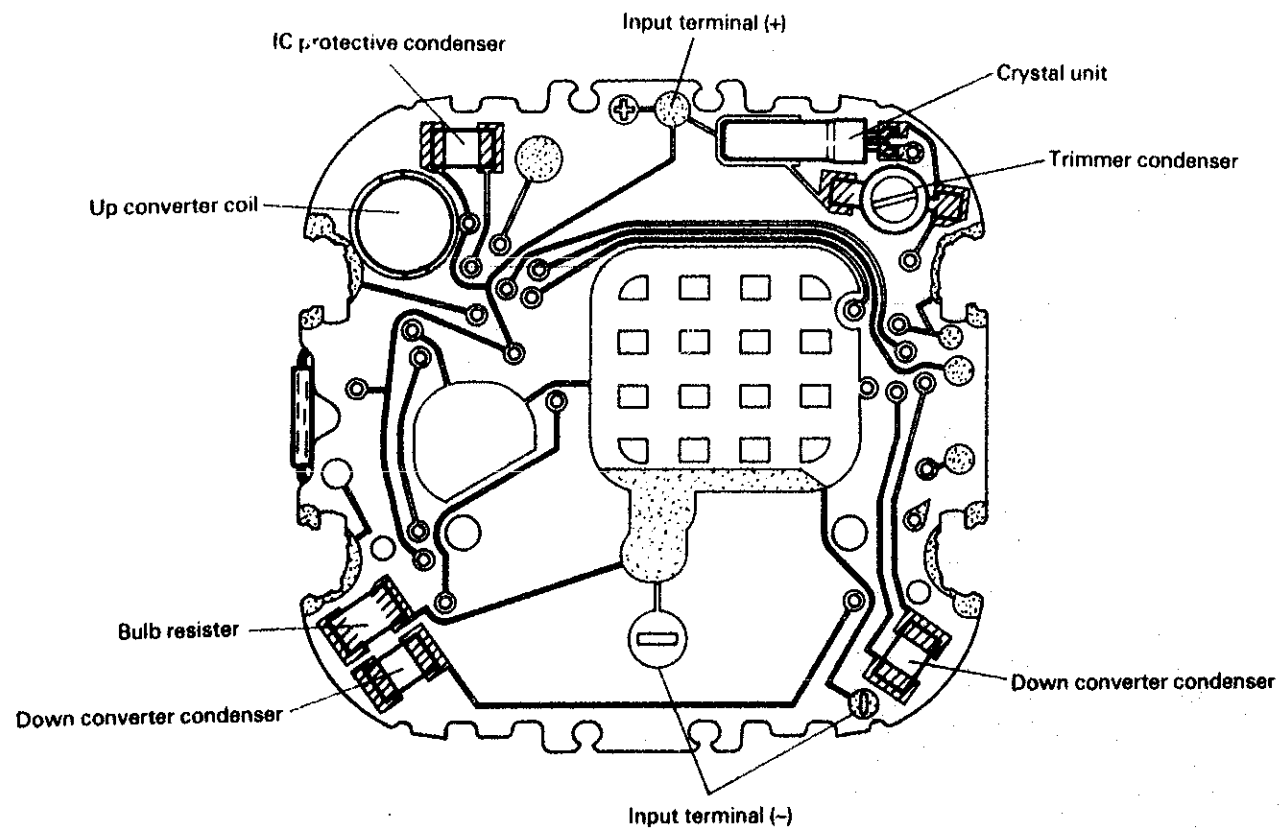
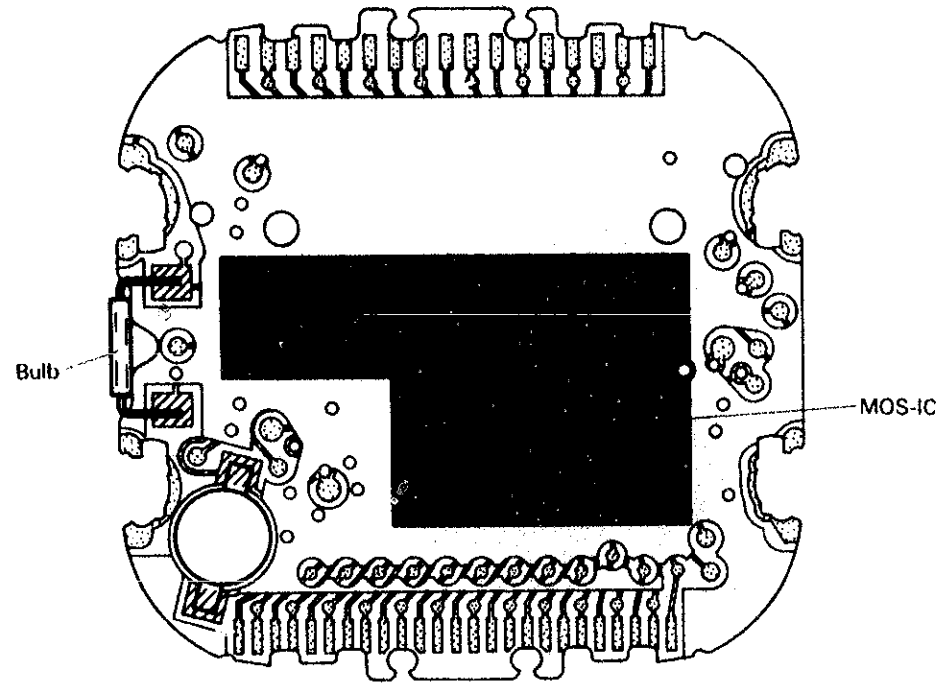

3. Relationship between the segments (Liquid Crystal Panel electrodes) and C-MOS-LSI output terminals

● Disignation of segment

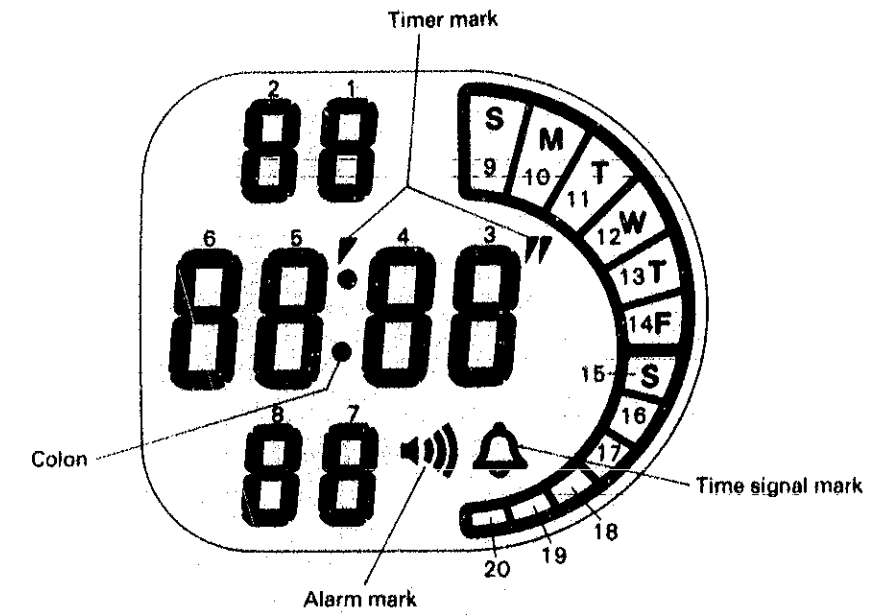

● Relationship between the segments and C-MOS-LSI output terminals

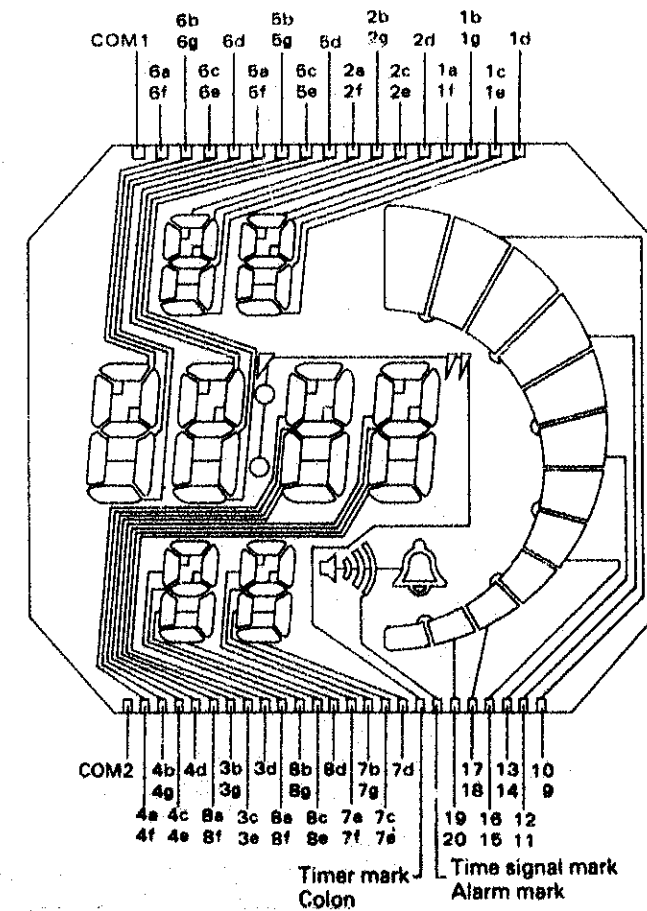

F

LIQUID CRYSTAL PANEL AND CIRCUIT BLOCK

- Refer to "Relationship between the segments (Liquid Crystal Panel electrodes) and C-MOS-LSI output terminals" on page 9

(1) Checking the liquid crystal panel

1. Use the Volt-ohm-meter.

Range to be used: OHMS $R \times 1 \sim R \times 1K$

NOTE:

Any range will do if more than 3V is applied to the terminal of the Volt-ohm-meter. In some Volt-ohm-meters, a voltage of more than 3V cannot be applied to the terminal. In this case, all segments are not displayed. Use a higher resistance range ($R \times 10K$).

2. Remove the liquid crystal panel from the module and turn it to the reverse side.
3. Check that the corresponding segment is displayed.

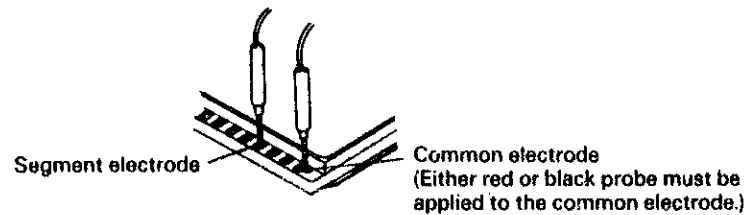

Not displayed: Defective
Replace the liquid crystal panel.

(2) Checking the circuit block output

1. Disassemble the module and remove the circuit block.
2. Use the Volt-ohm-meter.

Range to be used: DC 3V

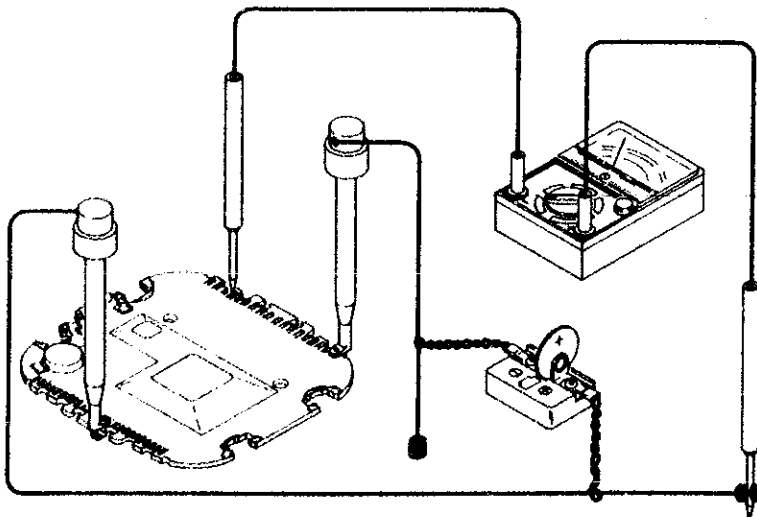

- to be continued -

F

LIQUID CRYSTAL PANEL AND CIRCUIT BLOCK

3. Red probe (+): Circuit block (+) terminal
Black probe (-): C-MOS-LSI output terminal
(If a segment is defective, connect the black probe to the corresponding electrode.)

0.8V or more: Normal
(The voltage at all terminals should be more than 0.8V.)
Less than 0.8V: Defective
Replace the circuit block.

G

ACCURACY

Any measuring gate can be used.
Check accuracy in the pattern segment checking mode.

- Pattern segment checking mode
Set the watch to the time setting mode and press buttons B and C simultaneously to obtain the pattern segment checking mode.

Monthly rate:
Less than 15 seconds: Normal
More than 15 seconds: Defective
Replace the circuit block.

H

FUNCTIONING AND ADJUSTMENT

Check functioning referring to "DISPLAY FUNCTION" on page 2.

- (1) Check that the time mode and alarm mode are changed correctly.
- (2) Perform alarm test and check that the alarm sounds correctly and alarm mark is displayed correctly.
- (3) Check the functioning for each digit in the time and calendar modes and confirm that the digit is advanced correctly.

Does not function correctly:
Replace the circuit block.

I

CONDUCTIVITY OF SWITCH COMPONENT

- (1) Check that the switch spring functions correctly.

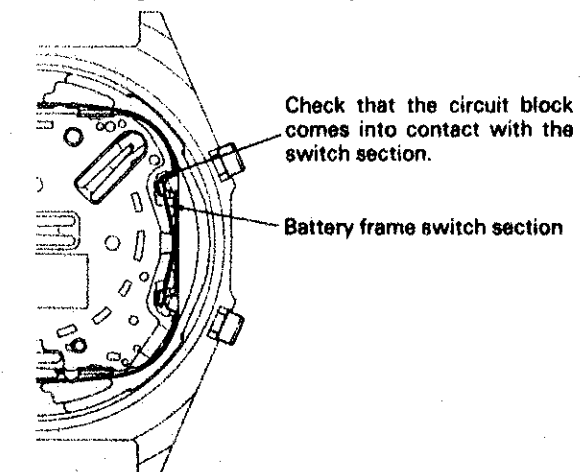

Does not function correctly:
Correct the switch spring with tweezers or replace the battery guard with a new one.

- (2) Check for dust, lint and other contamination of the connecting portions.

Contaminated:
Wipe off any foreign matter.

ALARM FUNCTION

- (1) ● Check the contacting portion of the piezo electric element on the case back and speaker lead terminal.
- Check the speaker lead terminal for deformation.
- (2) Measure the up converter coil resistance of the circuit block.
Range to be used: OHMS R x 1
- Checking
Apply the probes to the up converter coil terminals.
Either red or black probe will do.

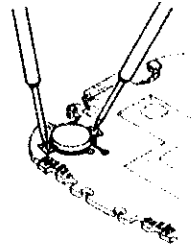

Contaminated:
Wipe off any foreign matter.

Deformed:
Correct with tweezers.

50Ω ~ 90Ω: Normal
Less than 50Ω: (Short-circuit)
More than 90Ω: Defective
(Broken wire)
Replace the circuit block with a new one.

VI. PARTS LIST for Cal. Y716A

PART NO.	PART NAME
4001 873	Circuit block
4248 871	Speaker lead terminal
4270 871	Battery connection (-)
4313 872	Connector
4395 974	Battery quard
★ 4510 575	Liquid crystal panel
★ 4410 576	Liquid crystal panel
4512 575	Liquid crystal panel frame
4521 911	Reflecting mirror
4530 230	Bulb
MAXELL CR2016 MATSUSHITA BR2016 SANYO CR2016	Lithium battery

Remarks:

Liquid crystal panel
★4510 575
★4510 576

The type of liquid crystal panel is determined based on the design of case.