

TECHNICAL GUIDE

AND
PARTS LIST

CAL. V011A

COMBINATION QUARTZ

CONTENTS

I. SPECIFICATIONS	1
II. LIST OF SCREWS USED.....	1
III. OPERATION.....	2
IV. DISASSEMBLING, REASSEMBLING AND LUBRICATING.....	3 ~ 4
V. CHECKING AND ADJUSTMENT	5 ~ 7
VI. PARTS LIST.....	8

I. SPECIFICATIONS

Item	Cal. No.	V011A	
Time Indication		Analogue Section	Digital Section
		Three Hands	Nematic Liquid Crystal, FEM (Field Effect Mode)
Driving system		Step motor (Load compensated driving pulse type)	Multiplex driving system
Display system			<ul style="list-style-type: none"> ● Calendar display ● Time display ● Alarm display ● Stopwatch display (up to 60 minutes)
Additional mechanism		<ul style="list-style-type: none"> ● Electronic circuit reset switch ● Second setting device 	<ul style="list-style-type: none"> ● Hourly time signal ● Alarm test system ● Illuminating light
Loss/gain		Monthly Rate: Less than 20 seconds at normal temperature range	
Movement size	Outside diameter	24.5 mm (6 - 12 H), 23.0 mm (3 - 9 H)	
	Casing diameter	—	
	Height	2.5 mm	
Regulation system		Trimmer condenser	
Quartz Tester measuring gate		Any gate can be used (Use the analogue section to measure accuracy.)	
Battery		SEIKO SR920W, Maxell SR920W Battery life is approximately 2 years. Voltage: 1.55V	
Jewels		1 jewel	

II. LIST OF SCREWS USED

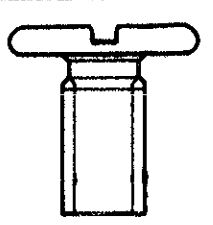
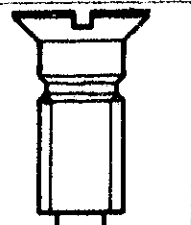
	012 168 ● Switch spring screw (B) 3 pcs. ● Train wheel bridge screw 1 pcs.
	016 700 ● Switch spring screw (A) 2 pcs.

III. OPERATION

● DISPLAY AND BUTTON OPERATION

The display changes with each press of "A" as follows:

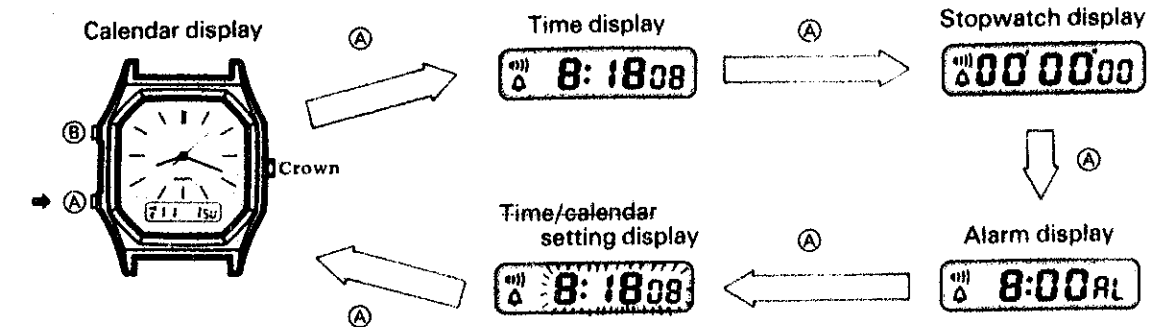

- Be sure to set the digital time first before setting the analogue.

● HOW TO SET THE DIGITAL TIME/CALENDAR

1. Press "A" to show the time/calendar setting display. The hour, minute and seconds digits start flashing.
2. Selection of the digits to be adjusted (flashing) is made in the following order by pressing "B":

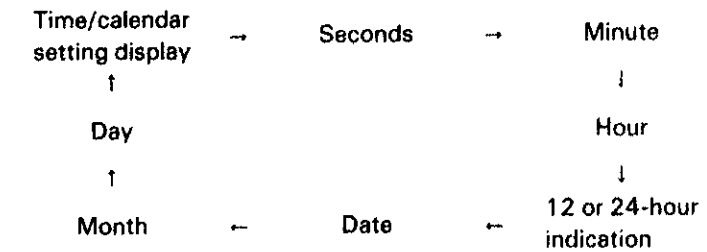

3. One digit (flashing) is advanced with each press of "A". The digits except seconds are advanced quickly by keeping "A" pressed.

- NOTES:**
- ① When the seconds digits are flashing, the seconds are reset to "00" by pressing "A". When the seconds count any number from "30" to "59" and "A" is pressed, one minute is added and the seconds are reset to "00".
 - ② When setting the hour in the 12-hour indication, be sure to check that AM/PM is properly set. Only "P" (PM) mark is displayed. For the AM setting, there is no indication.
 - ③ When the time function is displayed in the 24-hour indication, the alarm function will also be displayed in the 24-hour indication.

4. After all adjustments are completed, press "B" to show the time/calendar setting display. Then press "A" to return to the calendar display.

NOTE: ④ If the watch is left untouched in the time/calendar setting function with the digits flashing it will automatically return to the calendar display in 1 to 2 minutes.

● HOW TO SET THE ANALOGUE TIME

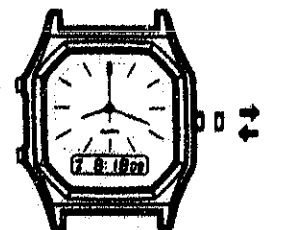

1. Pull out the crown when the second hand is at the 12:00 position, and the second hand will stop on the spot.
2. Turn the crown to set the desired hour and minute. When setting the minute hand, advance it 4 to 5 minutes ahead and then turn it back to the exact time.
3. Push in the crown when the seconds digits count "00" in the digital time display.



IV. DISASSEMBLING, REASSEMBLING AND LUBRICATING

Disassembling procedures: Figs. ① ~ ⑬
Reassembling procedures: Figs. ⑭ ~ ⑳

Lubricating:

Types of oil	Oil quantity
Moebius A	Standard 
SEIKO watch oil S-6	Small 

● Use the universal movement holder for disassembling and reassembling.

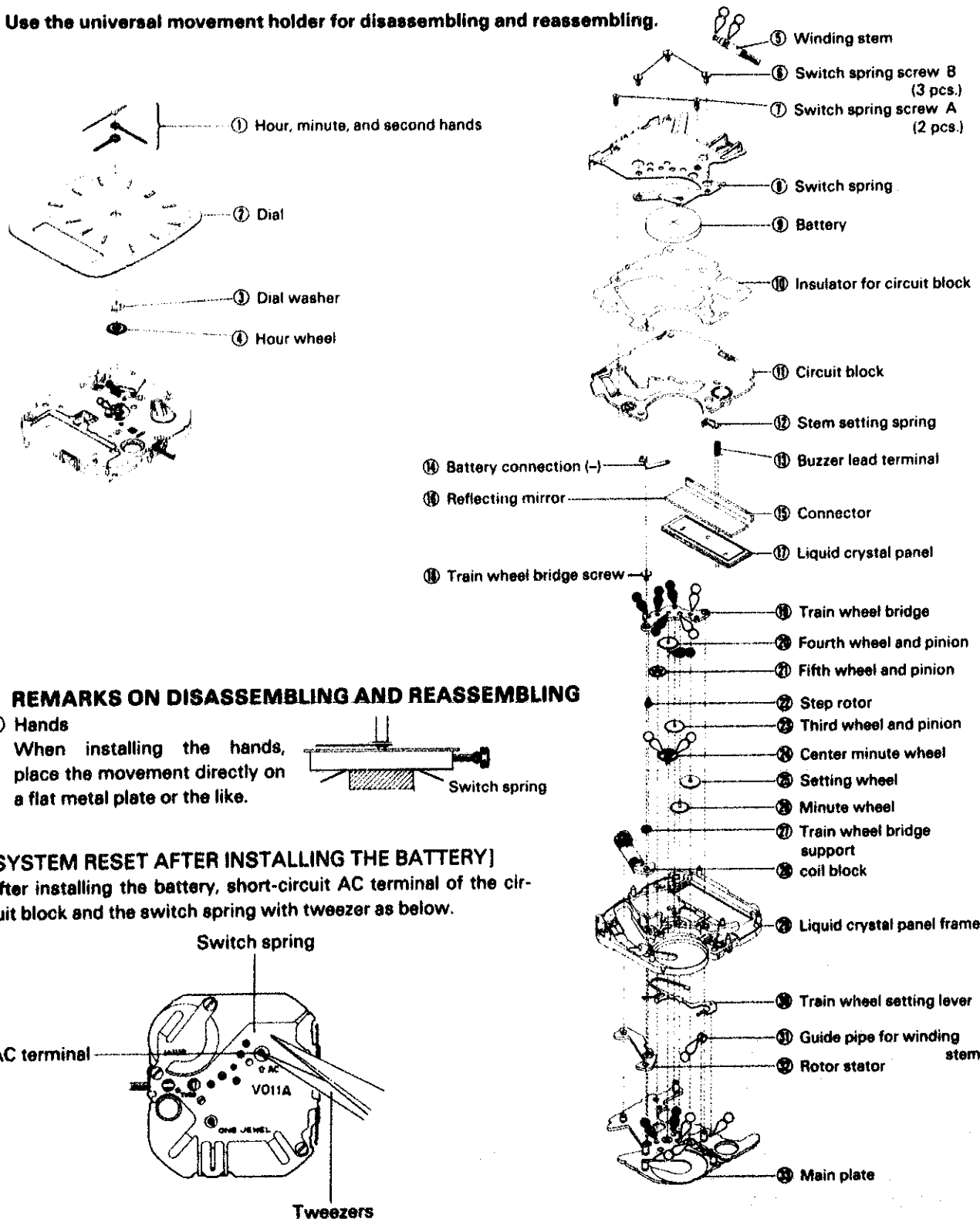

REMARKS ON DISASSEMBLING AND REASSEMBLING

① Hands

When installing the hands, place the movement directly on a flat metal plate or the like.

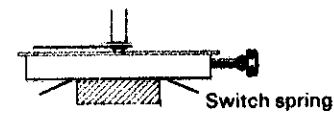

[SYSTEM RESET AFTER INSTALLING THE BATTERY]

After installing the battery, short-circuit AC terminal of the circuit block and the switch spring with tweezers as below.

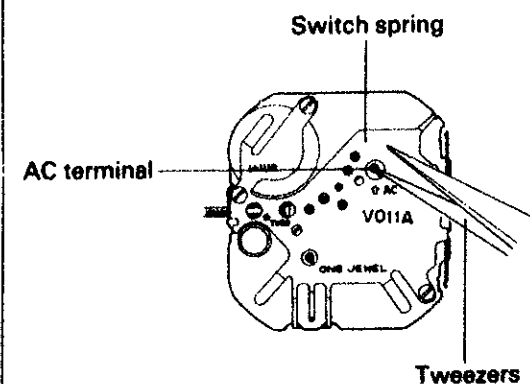

REMARKS ON DISASSEMBLING AND REASSEMBLING

⑤ Winding stem

● How to remove

Insert the tip of a screwdriver into the hole marked by "TURN ⇄", then turn the screwdriver about 90° in either direction, and slowly pull out the winding stem.

Hole (insert the tip of a screwdriver here)

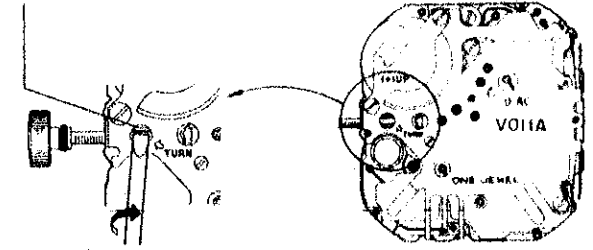

⑧ Switch spring, ⑨ Battery

● How to install

- 1) Set the switch spring, and tighten both of the two switch spring screws A (Fig. 1).
- 2) Have the hook portion (2 places) of the switch spring catch the liquid crystal panel frame (Fig. 2 & 3).
- 3) Lift up the battery clamp portion by finger and insert the battery sideways (Fig. 4).
- 4) Tighten the three switch spring screws B (Fig. 1).

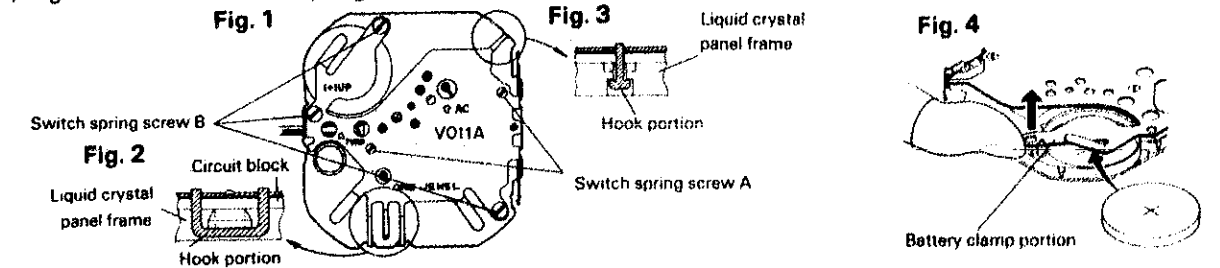

⑬ Buzzer lead terminal

● Setting position

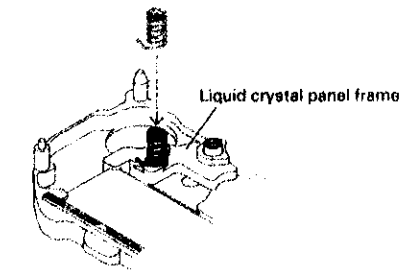

⑮ Reflecting mirror, ⑰ Liquid crystal panel

● How to install

Slide the liquid crystal panel in the direction indicated by the arrow to set it in position to the liquid crystal panel frame (Fig. 1). Then, slide the reflecting mirror in the direction indicated by the arrow until the other end of the reflecting mirror is set inside of the location guide pin (Fig. 2 & 3).

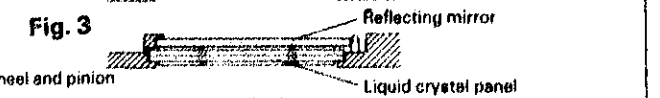

⑱ Train wheel bridge

● Setting position

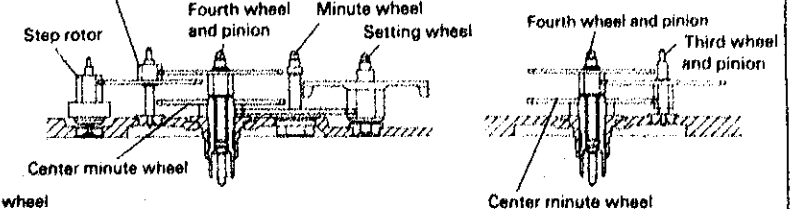
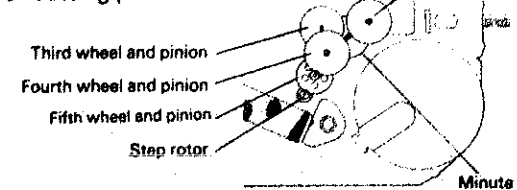

⑳ Train wheel setting lever

● Remarks on installing

After reassembling ⑭ Main plate through ① Switch spring screw B, turn over the movement, and hook the end of the train wheel setting lever to the liquid crystal panel frame as shown in the illustration on the right.

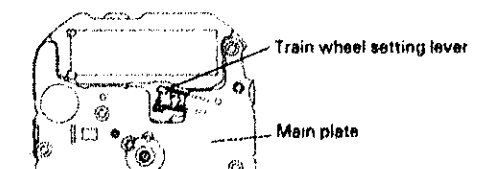

V. CHECKING AND ADJUSTMENT

1. STRUCTURE OF THE CIRCUIT BLOCK

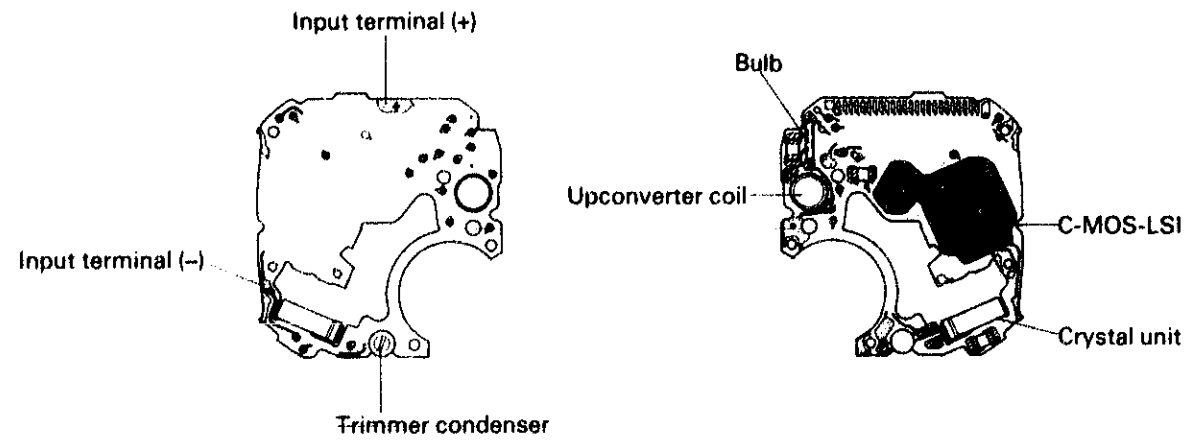

2. RELATIONSHIP BETWEEN THE SEGMENT (LIQUID CRYSTAL PANEL ELECTRODE) AND THE C-MOS-LSI OUTPUT TERMINAL

● Designation of the segment

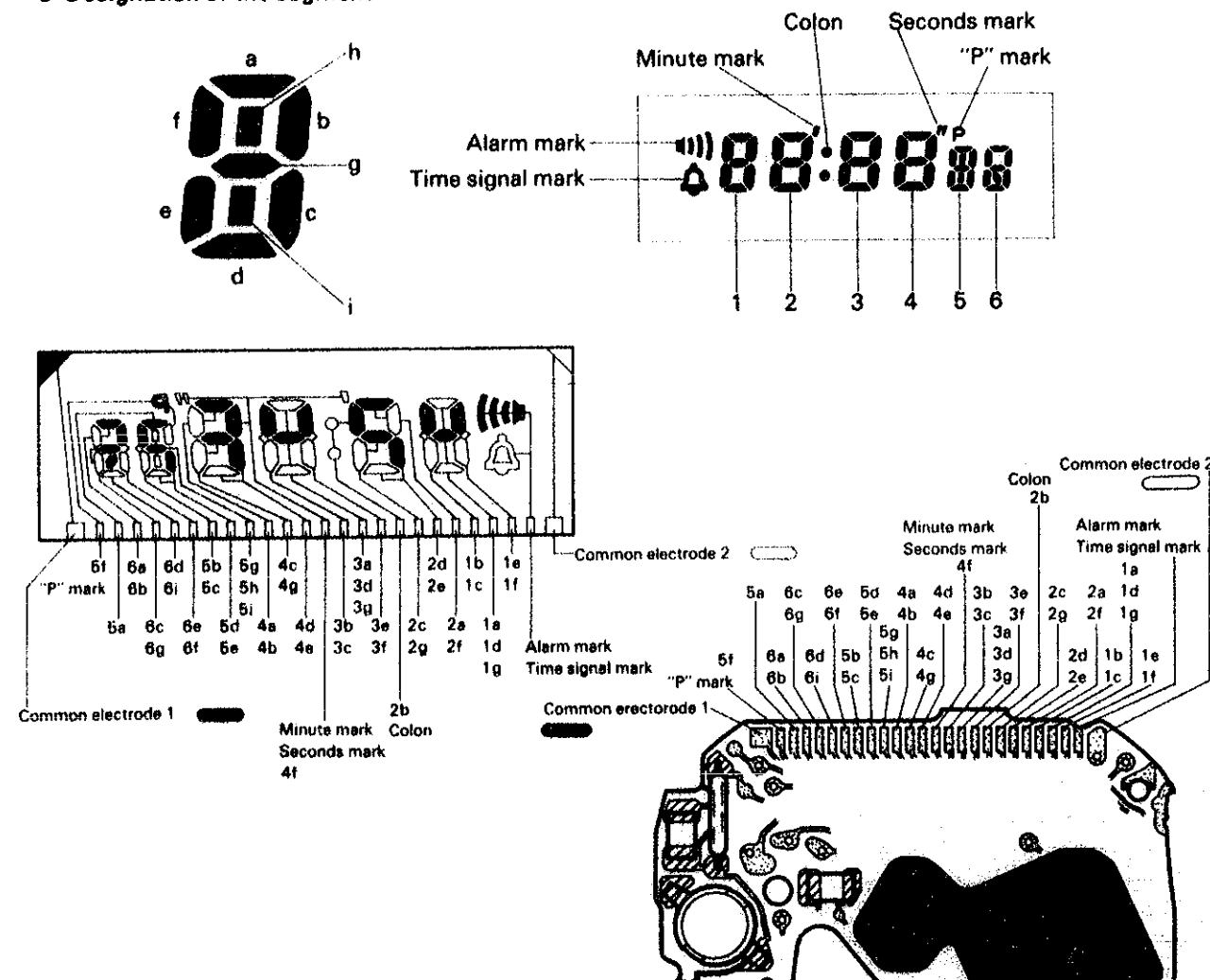

3. PROCEDURES FOR CHECKING AND ADJUSTMENT

- This section only gives the checking and adjustment procedure which is exclusive for cal. V011A. For the normal checking and adjustment, refer to the "TECHNICAL GUIDE GENERAL INSTRUCTION."

BATTERY VOLTAGE

Use the SEIKO Digital Multi Tester S-840A.
Range to be used: DC V

Result:
More than 1.57V: Normal
Less than 1.57V: Defective

COIL BLOCK

Check the coil block for broken wire and short circuit using the SEIKO Digital Multi Tester S-840A.
Range to be used: Ω

Result:
2.6 ~ 3.2 k Ω : Normal
Less than 2.6 k Ω (short circuit): Defective
More than 3.2 k Ω (broken wire): Defective

CURRENT CONSUMPTION

Use the SEIKO Digital Multi Tester S-840A with Multi adaptor MA-40.
Range to be used: μ A

- Notes: After setting S-840A with MA-40 as shown Fig. 1, short-circuit AC terminal of the circuit block and the switch spring with tweezers. (Refer to "SYSTEM RESET" on page 3).
Otherwise, the digital display will become disordered, and as a result current consumption cannot be measured correctly.

1. Check current consumption for the whole of the movement (module).
Red probe: Input terminal (+)
Black probe: Input terminal (-)

Result:
Less than 2.0 μ A: Normal
More than 2.0 μ A: Defective

Fig. 1

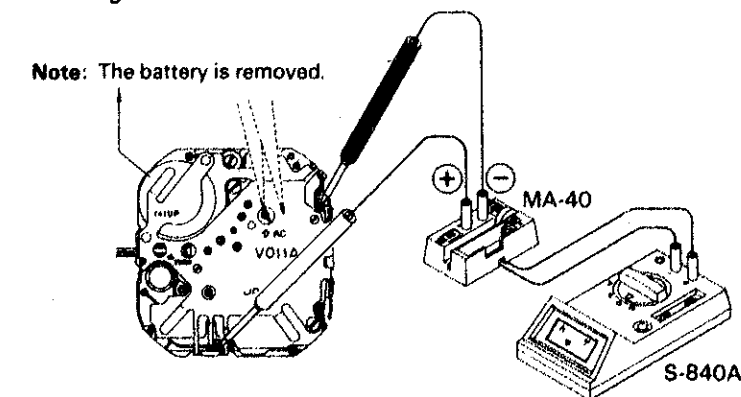

2. If the current consumption is more than 2.0 μ A, check the current consumption for the circuit block alone.
Red probe: Input terminal (+)
Black probe: Input terminal (-)

Result:
More than 1.2 μ A: Defective
Less than 1.2 μ A: Normal
Replace the circuit block or Liquid crystal panel.

- Notes: When the current consumption exceeds the standard value for the whole of the movement but is less than the standard value for the circuit block alone, overhaul and clean the movement parts and then measure current consumption for the whole of the movement again. The driving pulse generated to compensate a heavy load that may apply on the gear train, etc. is considered to cause excessive current consumption for the whole of the movement.

BULB CONDITION

Press button **(B)** in the time or calendar display.

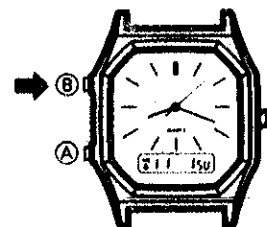

Result:
 Lights up: Normal
 Lights dimly: Defective
 Replace the battery.
 Does not light: Defective
 Replace the bulb or check the circuit block.

ALARM CONDITION

In the time or calendar display, check to see if the alarm rings by pressing buttons **(A)** and **(B)** simultaneously.

- ① Check to see if the alarm output signal correctly transmitted from the circuit block.
 Keep buttons **(A)** and **(B)** pressed simultaneously in the time or calendar display and check that the alarm output signal is output.
 ● Use the SEIKO Digital Multi Tester (S-840A).
 Range to be used: DCV
 Red probe: Switch spring
 Black probe: Buzzer lead terminal
- ② Check upconverter coil
 ● Use the SEIKO Digital Multi Tester (S-840A)
 Range to be used: Ω
- ③ Check the appearance of piezoelectric element.
 If items No. ① and ② above are normal, check the piezoelectric element for crack or peel off.

Result:
 The output voltage is displayed intermittently: Normal
 (The alarm output signal is output.)

The digits displayed remain "00.0": Defective
 Check the upconverter coil.

Result:
 120 Ω - 180 Ω : Normal
 Less than 180 Ω }
 More than 120 Ω }
 Defective
 Replace the circuit block.

ACCURACY

Use the analogue section to measure accuracy.

VI. PARTS LIST

CAL V011 A			
PARTS NO.	PARTS NAME	PARTS NO.	PARTS NAME
125 070	Train wheel bridge	4216 074	Insulator for circuit block
231 037	Third wheel & pinion	4239 038	Rotor stator
238 002	Guide pipe for winding stem	4245 082	Switch spring
* 241 089	Fourth wheel & pinion	4246 044	Buzzer lead terminal
* 241 116	Fourth wheel & pinion	4270 068	Battery connection (-)
* 241 193	Fourth wheel & pinion	4313 068	Connector
261 024	Minute wheel	* 4510 038	Liquid crystal panel (silver)
* 270 072	Center minute wheel	* 4510 040	Liquid crystal panel (gold)
* 270 119	Center minute wheel	4512 063	Liquid crystal panel frame
* 270 192	Center minute wheel	4521 063	Reflecting mirror
* 271 189	Hour wheel	4530 017	Bulb
* 271 190	Hour wheel	4589 013	Piezoelectric element
* 271 192	Hour wheel	011 583	Upper hole jewel for step rotor
281 013	Setting wheel	012 168	Train wheel bridge screw
* 351 161	Winding stem	012 168	Switch spring screw (B)
391 037	Train wheel setting lever	016 700	Switch spring screw (A)
426 070	Train wheel bridge support	032 046	Tube for coil block screw
491 141	Dial washer	032 047	Tube for train wheel bridge
637 007	Stem setting spring	032 047	Tube for circuit block screw
701 037	Fifth wheel & pinion		
4000 168	Circuit block	● SEIKO SR920W	Battery
4002 030	Coil block	● MAXELL SR920W	
4146 031	Step rotor		

Remarks:

- * Forth wheel & pinion, Center minute wheel, Hour wheel
 There are three different types as specified below.

Combination:

*Type	Fourth wheel & pinion	Center minute wheel	Hour wheel
M	241 089	270 072	271 189
L	241 116	270 119	271 190
LL	241 193	270 192	271 192

* abbreviation

(Movement type) M Standard type
 L Long type
 LL Extra-Long type

* Liquid crystal panel

4510 038
 (Silver)
 4510 040
 (Gold)

Be sure that combination between the color of panel cover and liquid crystal panel should be matched according to the "Casing Parts Catalogue".

* Winding stem

The type of winding stem is determined based on the design of case. Check the case number and refer to "Casing Parts Catalogue" to choose a corresponding winding stem.

* SWITCH-SPRING

4245086 (Pulsar Time marking)