

**SEIKO**

**DIGITAL QUARTZ**

**Cal. F051A**

**PARTS LIST**

# Cal. F051A

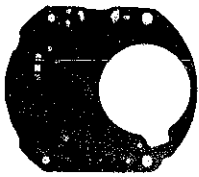

4001 115



4313 021

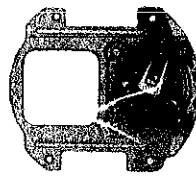

4398 049



4408 190

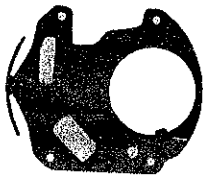

4457 004



☆4510 171

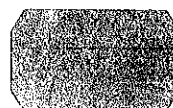

4521 019

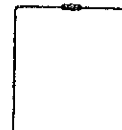

4530 230



4540 006



☆Maxell SR1130W

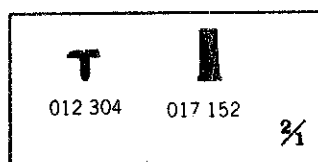

# Cal. F051A

## Characteristics

Casing diameter:  $\phi$  25.60 mm  
 Maximum height: 3.39 mm without battery  
 Frequency of quartz crystal oscillator: 32,768Hz (Hz = Hertz . . . . Cycle per second)  
 Time display: Digital Display System showing hour, minute and second.  
 Calendar display: Digital Display System showing day and date. (A.M./P.M. indication, month and language symbol are displayed only when the time and calendar digits are adjusted.)  
 One desired language can be selected among five languages (English, Spanish, French, German and Italian) to indicate the day of the week.  
 Display medium: Nematic Liquid Crystal, FE-Mode  
 Time micro adjustor: Trimmer condenser system  
 Illuminating light: Illuminates all the digital displays in the dark by depressing the light button.  
 Battery life indicator: All the digits in the display begin flashing.

PART NO.	PART NAME	PART NO.	PART NAME
4001 115	Circuit block		
4313 021	Connector		
4398 049	Liquid crystal panel frame		
4408 190	Insulating spacer for circuit block		
4457 904	Circuit block cover with switch spring		
☆4510 171	Liquid crystal panel (Silver)		
☆4510 172	Liquid crystal panel (Gold)		
4521 019	Reflecting mirror		
4530 230	Bulb		
4540 006	Spring for liquid crystal panel		
012 304	Screw for circuit block cover with switch spring		
017 152	Tube for circuit block cover with switch spring screw		
☆Maxell SRI 130W ☆Toshiba WG-10 ☆U.C.C. 389	Silver oxide battery		

## Remarks:

### Liquid crystal panel

☆4510 171 } ...Be sure that the combination between the color of panel cover and liquid crystal panel  
 ☆4510 172 } should be matched according to the "SEIKO Quartz Casing Parts List".

### Battery

The applied battery for this calibre might be added the substitutive in the future. In that case, please refer to separate "BATTERIES FOR SEIKO QUARTZ WATCHES".

☆ ⇨ Please see remarks.

Part numbers in light letters are not shown in photos.

# TECHNICAL GUIDE

## SEIKO

## DIGITAL QUARTZ

CAL.F051A

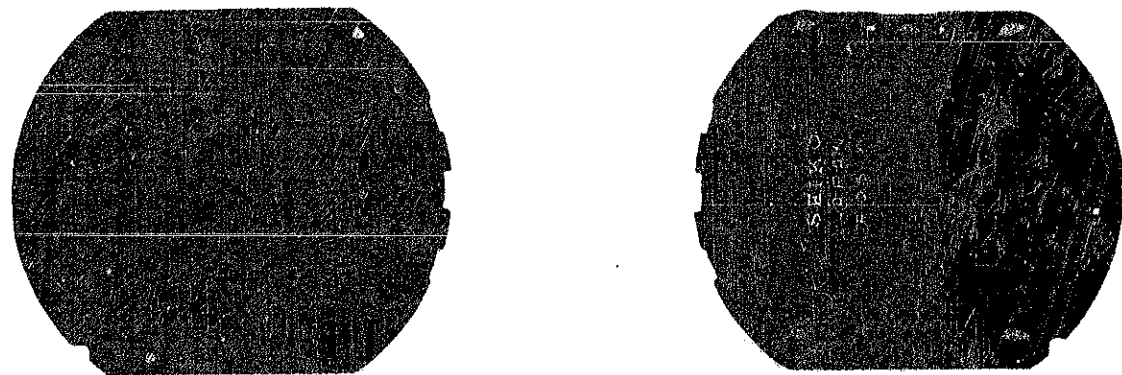

### CONTENTS

I. SPECIFICATIONS AND FEATURES .....	1
1. Specifications .....	1
2. Features .....	1
II. AFTER-SALE SERVICING INSTRUMENTS AND MATERIALS .....	2
III. CASE .....	2
1. How to disassemble the module .....	2
2. How to replace the glass .....	2
IV. DISASSEMBLING AND REASSEMBLING .....	3
1. Disassembling and reassembling .....	3
V. CHECKING AND ADJUSTMENT .....	6
1. Guide table for checking and adjustment .....	6
2. Procedures for checking and adjustment .....	8
A : Check battery voltage .....	8
B : Check battery conductivity .....	8
C : Check conductivity of liquid crystal panel, circuit block, insulating spacer for circuit block and connector .....	9
D : Check switch components .....	9
E : Check circuit block and liquid crystal panel .....	10
F : Check current consumption .....	10
G : Check accuracy .....	11
H : Check battery life indicator .....	11
I : Check bulb condition .....	12
J : Check functioning .....	12

**Remarks for disassembling and reassembling**

① **Screw for circuit block cover with switch spring**  
Tighten the two screws on the battery side first.

④ **Connector**  
Although two connectors are used, there is no difference between the two. The black portions are conductive. Check to see if there are any scratches or contamination.

⑤ **Liquid crystal panel frame**

- **How to disassemble**  
Push the tip of a screwdriver into the arrow-marked portions and pry up gradually for disassembling.
- Check to see if the insulating spacer for circuit block is fixed to the liquid crystal panel frame.

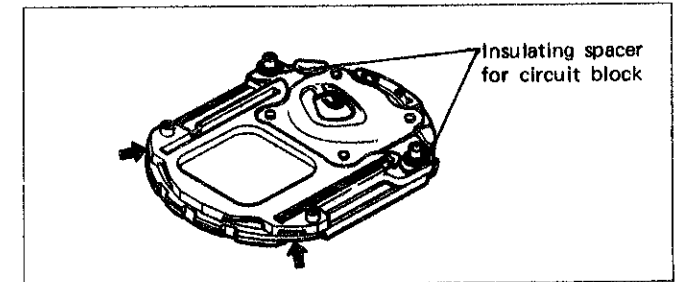

⑥ **Reflecting mirror**

- **How to disassemble**  
The reflecting mirror is fixed with four pins. Be careful not to pry it up. Depress it slightly for disassembling as shown in the illustration.

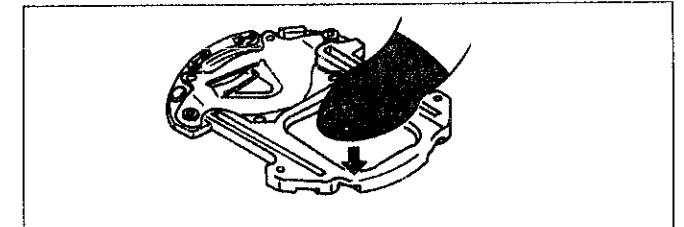

⑦ **Liquid crystal panel**

Use fingercots to disassemble and reassemble the liquid crystal panel. Be careful not to push the surface of the liquid crystal panel too hard.

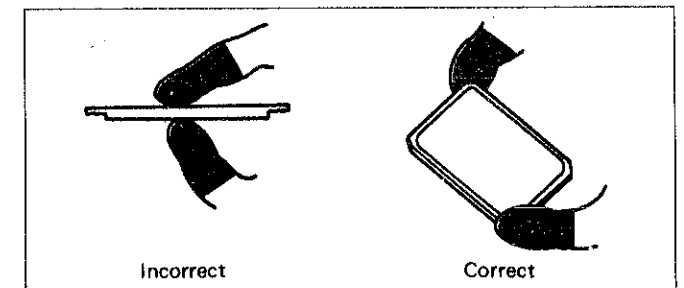

• **How to reassemble**

Reassemble the liquid crystal panel in such a way that its parts number portion comes to the top when the arrow-marked portions (button positions) of the module framework are on the right side. (The liquid crystal panel is fixed in the liquid crystal panel holder.)

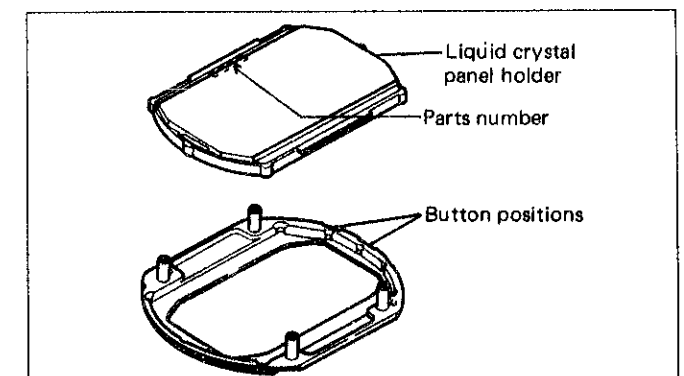

**How to reassemble the bulb**

Put the bulb lead wires through the holes of liquid crystal panel frame and reassemble the bulb as shown in the illustration.

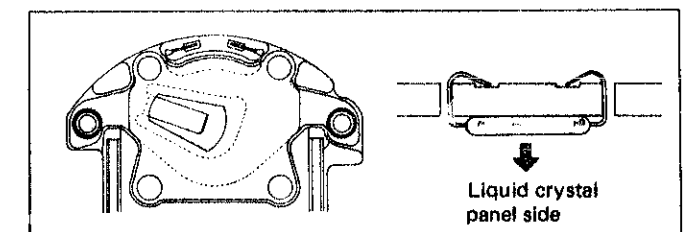

---

---

Cal. F051A

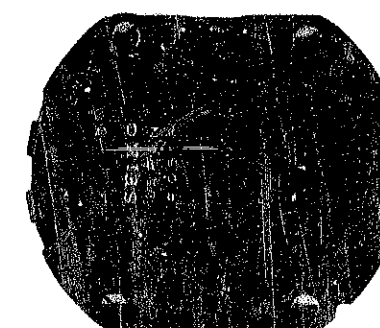
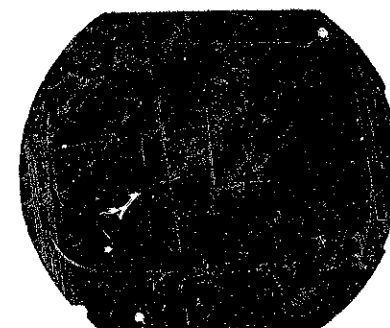

Module

## I. SPECIFICATIONS AND FEATURES

### 1. Specifications

Item	Calibre No. F051A
Display medium	Nematic Liquid Crystal, FEM (Field Effect Mode)
Display system	<ul style="list-style-type: none"> <li>Time &amp; Calendar display Hour (12 hour indication), minute, second, date, and day of the week Day: One of five languages can be selected (English, Spanish, French, German and Italian) to indicate the day of the week. Date: Automatic calendar system (Automatically adjusts for even and odd months except February of leap years.)</li> <li>"A" (for AM)/"P" (for PM), month and language symbol are displayed when the time and calendar digits are adjusted. Language symbol: (E) - English, (ES) - Spanish, (F) - French, (d) - German, (I) - Italian</li> </ul>
Additional mechanism	<ul style="list-style-type: none"> <li>Battery life indicator (The entire display starts flashing when the battery life comes to an end.)</li> <li>Illuminating light</li> </ul>
Crystal oscillator	32,768 Hz (Hz = Hertz . . . . Cycle per second)
Loss/gain	Loss/gain at normal temperature range Mean monthly rate: less than 10 seconds Annual rate: less than 2 minutes
Casing diameter	φ25.3mm (21.5mm between 12 o'clock and 6 o'clock side)
Height	3.3mm without battery
Operational temperature range	-10°C ~ +60°C (14°F ~ 140°F)
Regulation system	Trimmer condenser
Battery power	Maxell SR1130W, Toshiba WG-10 or U.C.C.389 Battery life is approximately 3 years. (If the light is used five times a day for one second at a time.) Voltage: 1.55V
IC (Integrated Circuit)	C-MOS-LSI

### 2. Features

SEIKO Thin LC Digital Quartz Cal. F051A has the same high accuracy and reliability as those of the existing SEIKO digital quartz watches. It is a thin and compact dress type quartz oscillator watch.

- The hour, minute, second, date and day of the week digits which are most frequently referred to in daily use, are always displayed.
- One of the five languages can be selected (English, Spanish, French, German and Italian) to indicate the day of the week.

## II. AFTER-SALE SERVICING INSTRUMENTS AND MATERIALS

For after-sale servicing of SEIKO Thin Digital Quartz Cal. F051A, the following instruments and materials are necessary.

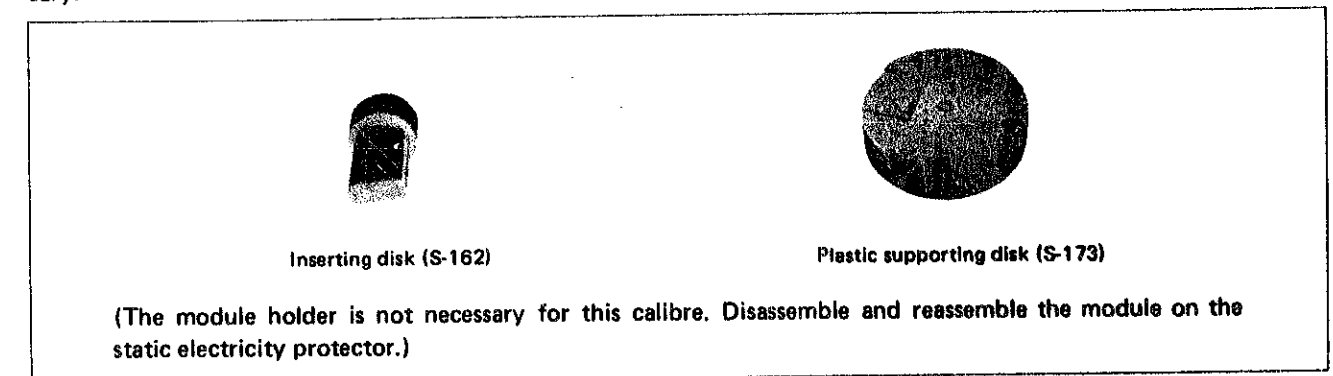

## III. CASE

### 1. How to disassemble the module (Ex. F051-5020)

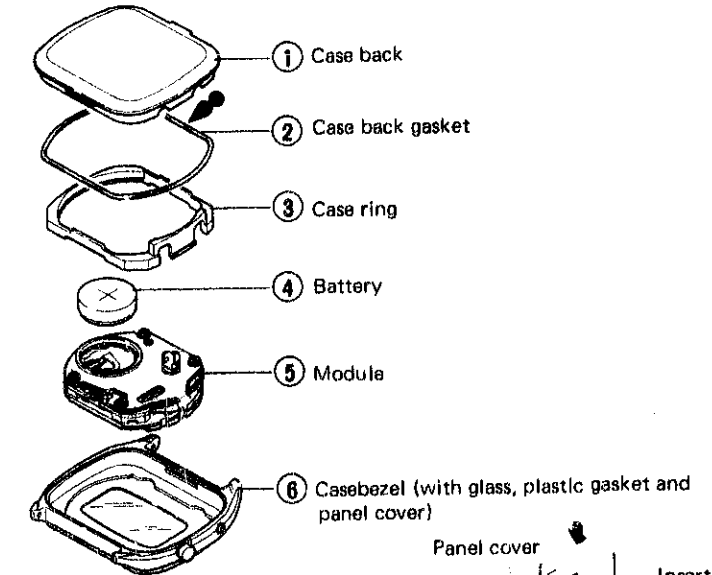

### 2. How to replace the glass

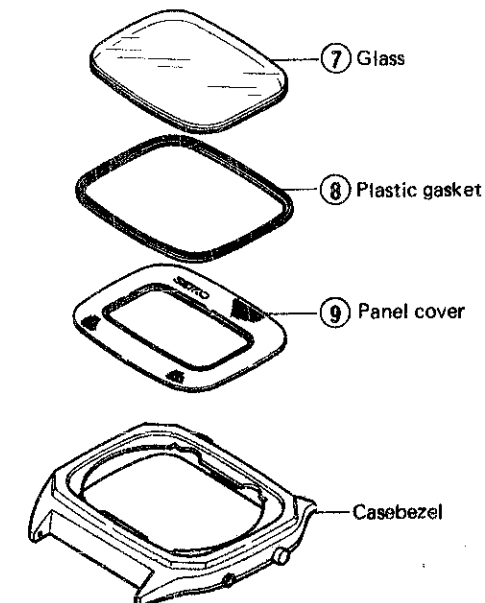

#### 2-1. Disassembling of the glass

Be careful not to depress the panel cover.

- Plastic gasket  
Be sure to replace the plastic gasket with a new one when the glass is disassembled.  
Be careful not to mistake the upper side for the lower side.

#### 2-2. Reassembling of the glass

Select the supporting disk contained in S-160 Disk unit, whose diameter is smaller than the inside diameter of the casebezel.

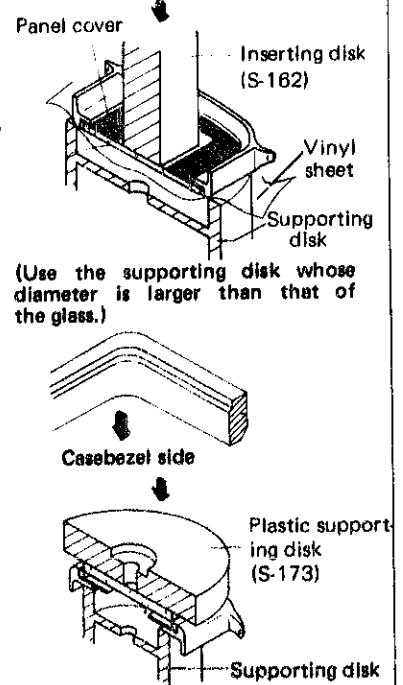

## IV. DISASSEMBLING AND REASSEMBLING

### 1. Disassembling and reassembling

Disassembling procedures Figs.: ① ~ ⑨

Reassembling procedures Figs.: ⑨ ~ ①

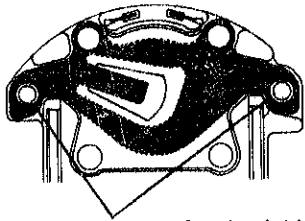

Insulating spacer for circuit block

- They are used to conduct the electric current (-) from the battery connection to the circuit block.
- It is not necessary to disassemble the insulating spacers for circuit block except when they are required to be replaced.

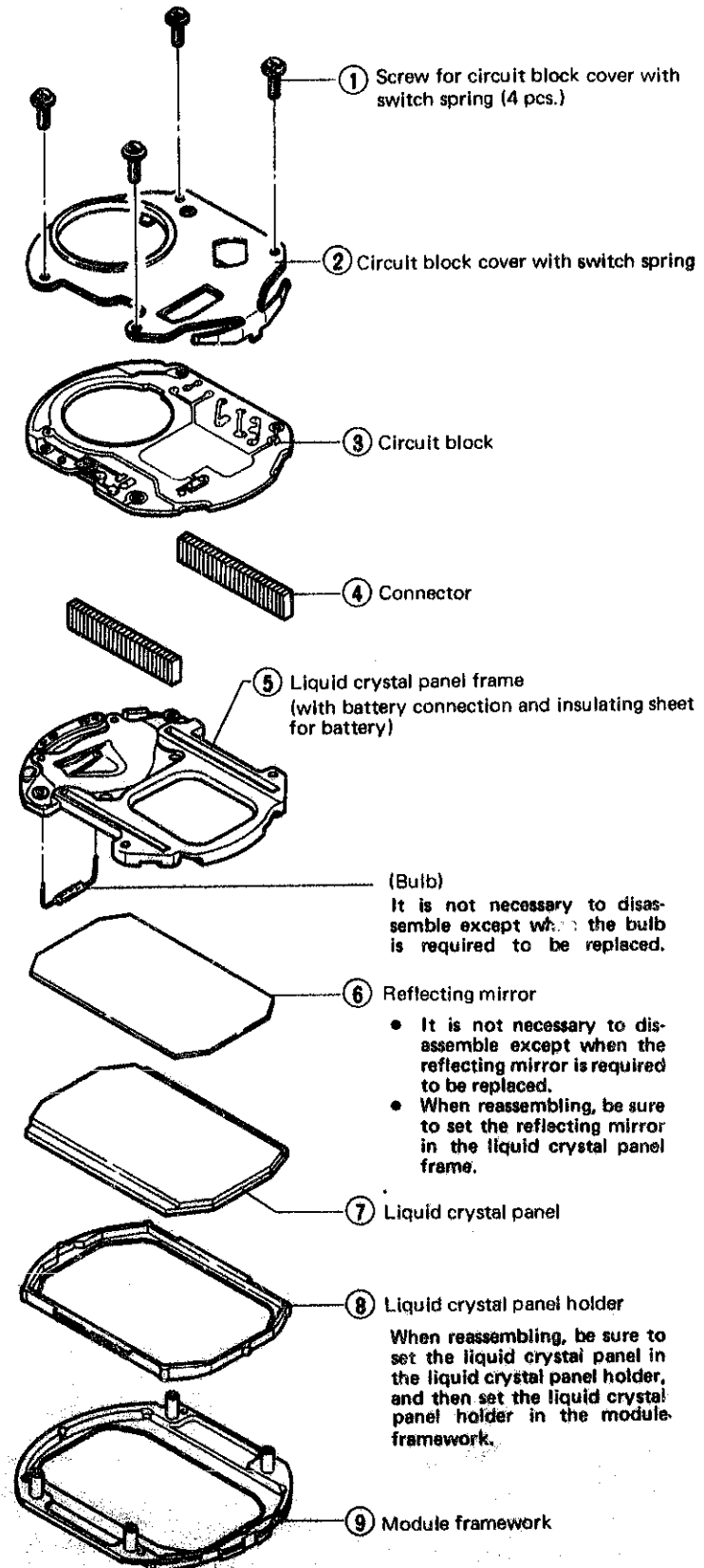



# V. CHECKING AND ADJUSTMENT

## 1. Guide table for checking and adjustment

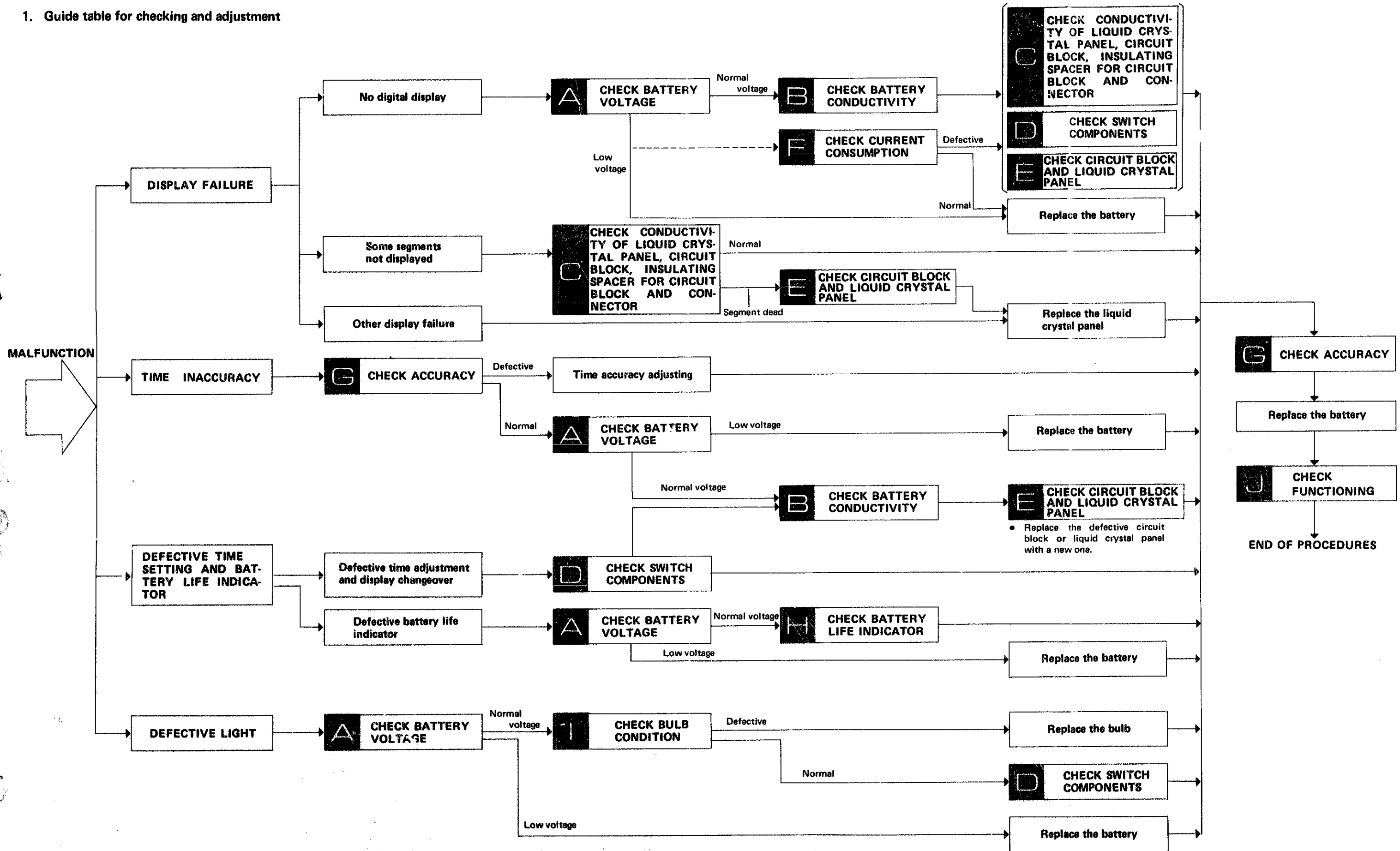

Note: If it is difficult to locate the malfunctioning portion, proceed to **CHECK FUNCTIONING** first.

V. CHECKING AND ADJUSTMENT



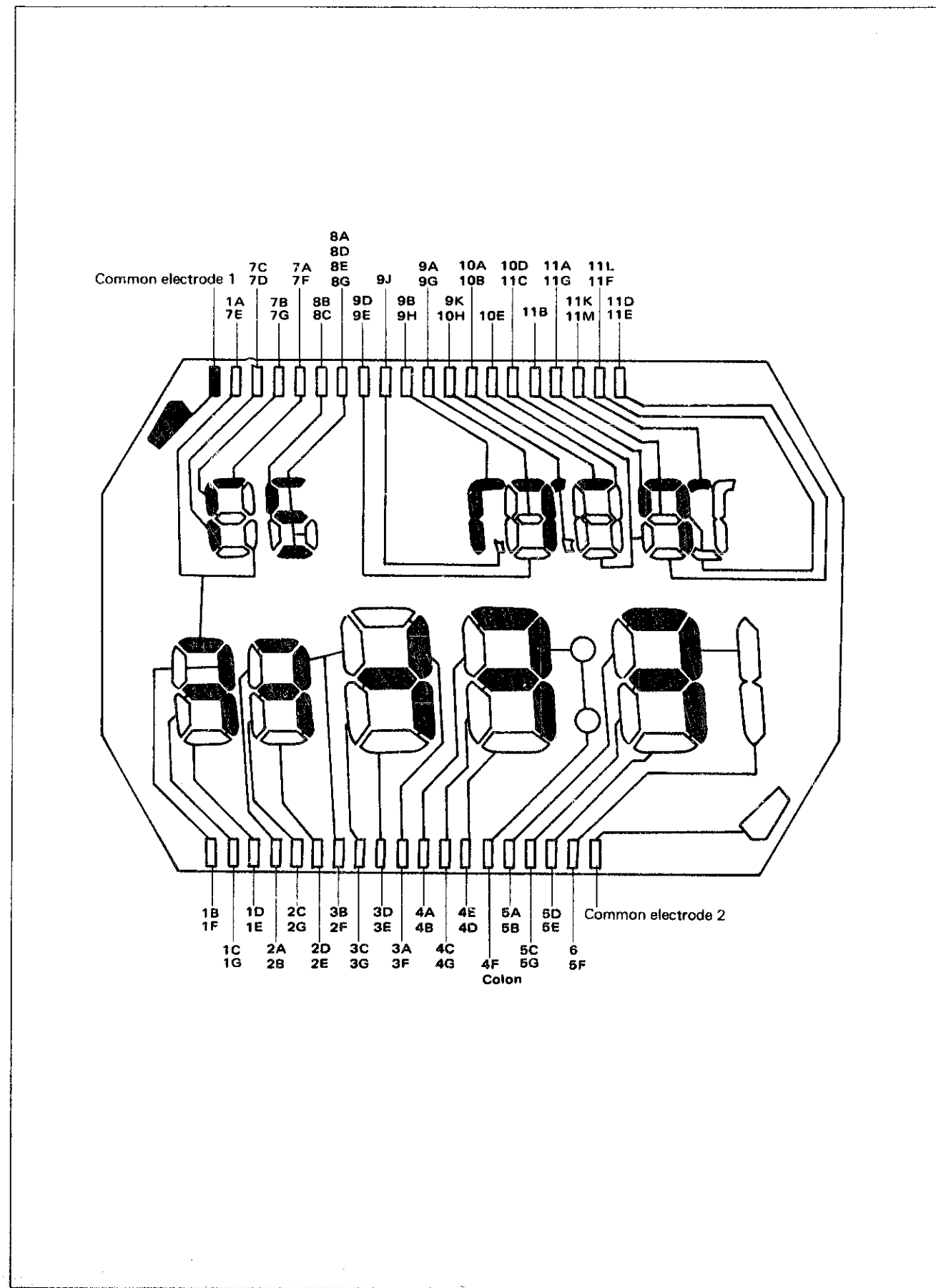
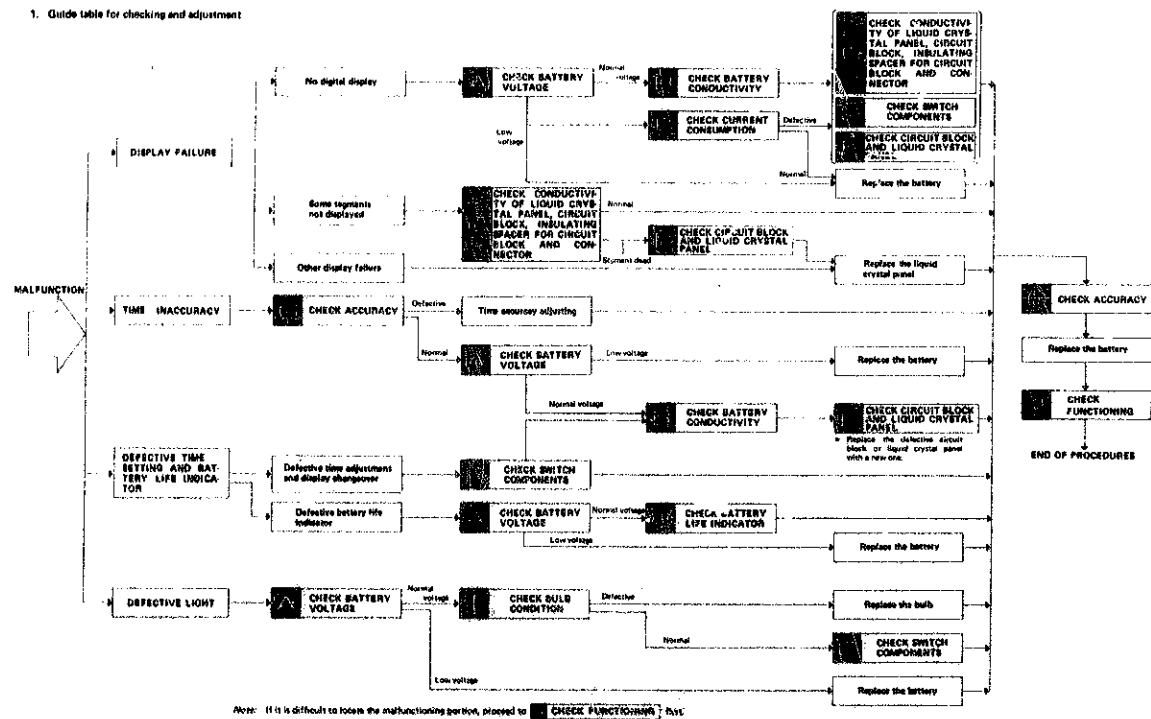

1. Guide table for checking and adjustment

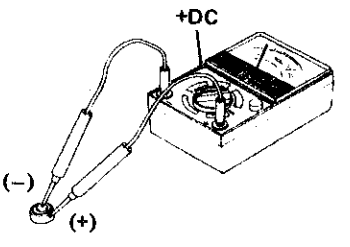
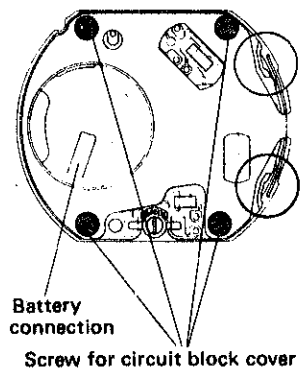

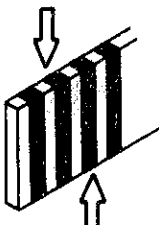
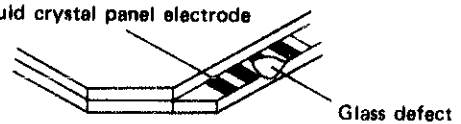
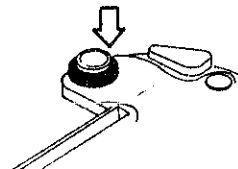
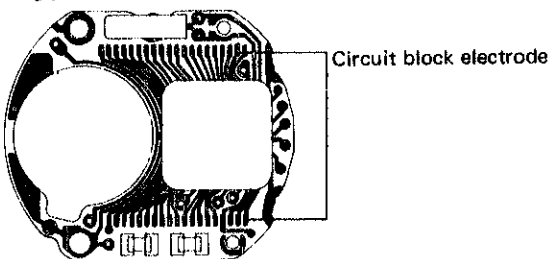
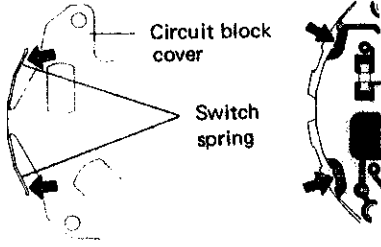
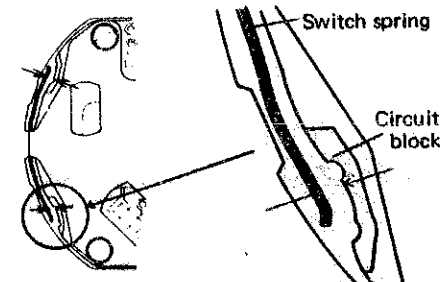

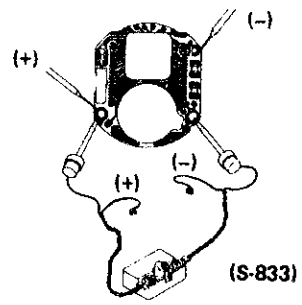
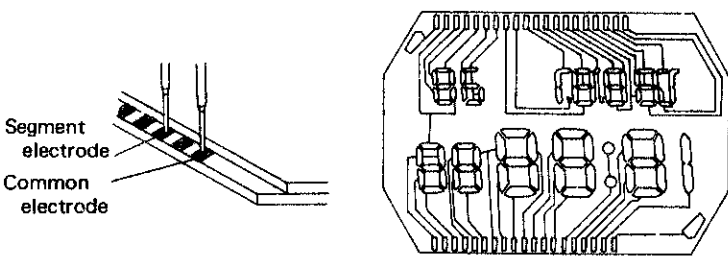
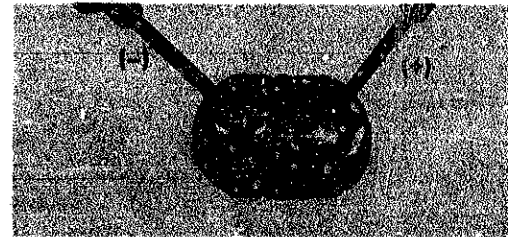

## 2. Procedures for checking and adjustment

	Procedure	Result and repair
CHECK BATTERY VOLTAGE	<p>Use the following procedures to check battery voltage.</p> <p>(1) Set up the Volt-ohm-meter. Range to be used: DC 3 V</p> <p>(2) Measuring Probe Red (+): Battery surface (+) Probe Black (-): Battery surface (-)</p> 	<p>More than 1.5V: Normal Less than 1.5V: Defective Replace the battery.</p>
CHECK BATTERY CONDUCTIVITY	<p><b>First Check</b> Check for any contamination on the battery, battery connection and circuit block cover with switch spring. Be especially careful to check the portions enclosed with a circle in the illustration.</p>  <p><b>Second Check</b> Make sure that the screws for circuit block cover with switch spring are tightened firmly.</p> <p><b>Third Check</b> Check to see if there is battery electrolyte leakage. When there is battery electrolyte leakage, follow the procedures below.</p> <p>(1) Remove the module from the case. (2) Disassemble the module. (3) Clean the parts contaminated with battery electrolyte.</p> <ul style="list-style-type: none"> <li>• Clean the circuit block.             <ol style="list-style-type: none"> <li>1. Wipe off battery electrolyte with a cloth moistened with distilled water. (If distilled water is not available, use tap water.) Then wipe it off with a cloth moistened with alcohol.</li> </ol> <p><i>Note:</i></p> <ul style="list-style-type: none"> <li>• Do not use a cloth which gives off lint such as gauze, flannel, etc.</li> <li>• Do not expose the trimmer condenser to water or alcohol.</li> </ul> <ol style="list-style-type: none"> <li>2. Dry with cool air by using a dryer.</li> </ol> </li> <li>• Clean the other parts.             <ol style="list-style-type: none"> <li>1. Wipe off battery electrolyte on the other parts with a soft brush moistened with distilled water (or normal tap water).</li> <li>2. Dry with cool air by using a dryer.</li> </ol> </li> </ul> <p>(4) Reassemble the module. Replace the battery with a new one. (5) Check to see if the time and calendar setting functions and the current consumption are normal.</p>	<p>Uncontaminated: Normal Contaminated: Defective Wipe off any foreign matter.</p> <p>No loosened screws: Normal Loosened screws: Defective Retighten the screws.</p> <p>No battery electrolyte leakage: Normal Battery electrolyte leakage: Defective Wipe off battery electrolyte by following the repairing procedures on the left.</p>

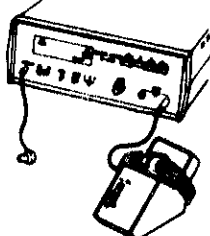
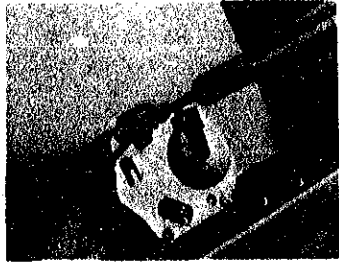
	Procedure	Result and repair
CHECK CONDUCTIVITY OF LIQUID CRYSTAL PANEL, CIRCUIT BLOCK, INSULATING SPACER FOR CIRCUIT BLOCK AND CONNECTOR	<p><b>First Check</b> Check for any contamination, scratch and break of the connector.</p>  <p>Be sure to check the connecting portion of the liquid crystal panel and the circuit block carefully.</p> <p><b>Second Check</b> Check for any contamination and glass defect of the liquid crystal panel electrode (the connecting portion with the connector).</p>  <p>Liquid crystal panel electrode Glass defect</p> <p><b>Third Check</b> Check for any contamination on the insulating spacer for circuit block.</p>  <p>Be sure to check the connecting portion with the circuit block carefully.</p> <p><b>Fourth Check</b> Check for any contamination on the circuit block electrode (the connecting portion with the connector).</p>  <p>Circuit block electrode</p>	<p>No contamination, scratch or break: Normal</p> <p>Contaminated: Defective Clean. Scratched or broken: Defective Replace the connector with a new one.</p> <p>No contamination or glass defect: Normal Contaminated: Defective Wipe off any foreign matter. Glass defect: Defective Replace the liquid crystal panel with a new one.</p> <p>Untaminated: Normal Contaminated: Defective Wipe off any foreign matter.</p> <p>Untaminated: Normal Contaminated: Defective Wipe off any foreign matter.</p>
CHECK SWITCH COMPONENTS	<p><b>First Check</b> Check for any contamination on the switch spring of the circuit block cover and the circuit block.</p>  <p>Circuit block cover Switch spring</p> <p><b>Second Check</b> Check for clearance between the switch spring and the circuit block.</p>  <p>Switch spring Circuit block</p>	<p>Untaminated: Normal Contaminated: Defective Wipe off any foreign matter.</p> <p>Clearance: Normal No clearance: Defective Correct the switch spring with tweezers so that there is a clearance.</p>

	Procedure	Result and repair
CHECK CIRCUIT BLOCK AND LIQUID CRYSTAL PANEL	<p><b>First Check</b> Check to see if the electric signal flows into the connector from the circuit block correctly.</p>  <p>(+) (-) (+) (-) (S-833)</p> <ol style="list-style-type: none"> <li>Supply voltage power (1.5V) to the circuit block by using the electricity supplier (S-833).</li> <li>Set up the Volt-ohm-meter. Range to be used: DC 3 V</li> <li>Measuring Probe Red (+) . . . . . Circuit block (+) Probe Black (-) . . . . . Circuit block electrode (Apply to several portions.)</li> </ol> <p><b>Second Check</b> Check for any broken panel pattern, short circuit, etc. of the liquid crystal panel.</p> <ol style="list-style-type: none"> <li>Set up the Volt-ohm-meter. Range to be used: OHMS R x 1</li> <li>Disassemble the liquid crystal panel from the module and turn the liquid crystal panel upside down.</li> <li>Measuring Apply the red and black probes of the Volt-ohm-meter to the common electrode and the segment electrode of the liquid crystal panel. (There are two common electrodes. Either common electrode will do.)</li> </ol>  <p>Segment electrode Common electrode</p>	<p>More than 0.8V: Normal Less than 0.8V: Defective Replace the circuit block with a new one.</p> <p>(The above voltage is obtained when measured by the Volt-ohm-meter S-831. If the other Volt-ohm-meter is used, the voltage obtained might be less than the above.)</p> <p>Lights up: Normal Does not light up: Defective Replace the circuit block with a new one.</p>
CHECK CURRENT CONSUMPTION	<p>Check to see if the current consumption is normal.</p> <ol style="list-style-type: none"> <li>Set up the Volt-ohm-meter. Range to be used: DC 12<math>\mu</math>A</li> <li>Measuring Probe Red (+) . . . . . Battery connection Probe Black (-) . . . . . Battery surface (-)</li> </ol>  <p>(-) (+)</p>	<p>Less than 2.0 <math>\mu</math>A: Normal More than 2.0 <math>\mu</math>A: Defective Proceed to ,  and .</p>

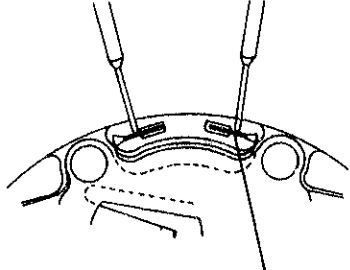
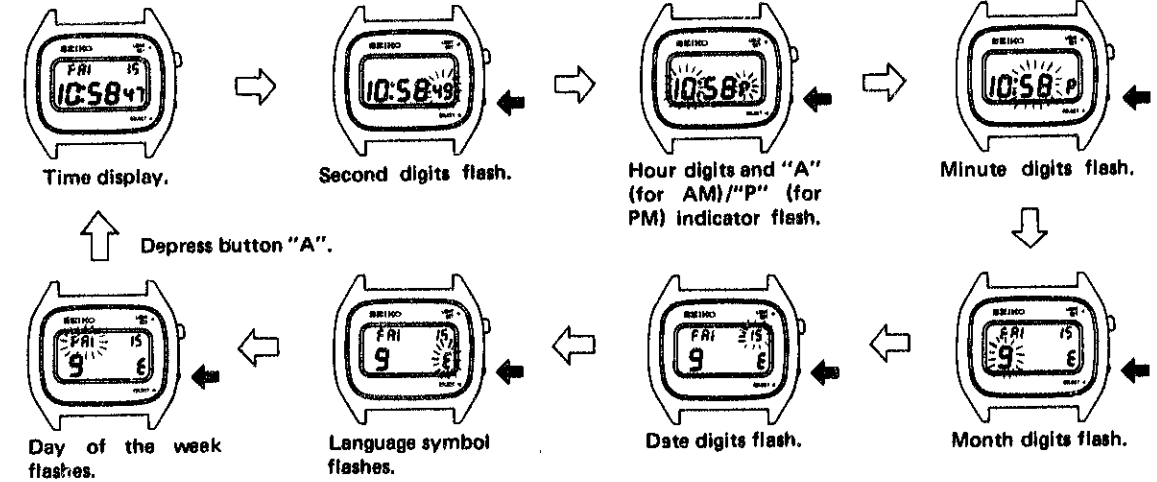
	Procedure	Result and repair
CHECK ACCURACY	<p>Check gain and loss of time. As the special circuit is being used, check accuracy with all segments displayed.</p> <p>(1) Display all segments by depressing and holding the switch spring (arrow-marked) for three or four seconds.</p>  <p>Depress and hold three or four seconds.</p> <p>(2) Measuring</p>  <p>Set the microphone switch to "LC. ON" position.</p> <ul style="list-style-type: none"> <li>Time accuracy adjusting Time accuracy is adjusted by turning the trimmer condenser.</li> </ul>  <p>After the time adjusting is completed, depress either button "A" or "B" to return to the time display.</p>	<p>Neither gain nor lose: Normal Gain or lose: Defective Proceed to time accuracy adjusting.</p>
LIFE INDICATOR	<p>Check to see if the battery life indicator functions correctly.</p> <p><b>First Check</b></p> <p>(1) Set the voltage of the Micro Test at 1.35V.</p> <p>(2) Disassemble the battery from the module, and apply Micro Test's clip and probe to the module.</p> <p>Clip Red (+) . . . . . Circuit block cover Probe Black (-) . . . . . Battery connection</p> 	<p>Display flashes: Normal Display does not flash: Defective Replace the circuit block with a new one.</p>

	Procedure	Result and repair
CHECK BULB CONDITION	<p>Check to see if the bulb functions correctly.</p> <p>(1) Set up the Volt-ohm-meter. Range to be used: OHMS R x 1</p> <p>(2) Measuring Apply the probes to both sides of the bulb lead wire. (Either red or black probe will do.)</p>  <p>Bulb lead wire</p>	<p>Lights up: Normal Does not light up: Defective Replace the bulb with a new one.</p>
CHECK FUNCTIONING	<p>Check to see if display changeover and adjustment can be made correctly by button operation.</p> <p><b>First Check</b> Check to see if each display can be selected by depressing button "A". (Also check to see if each display can be set.)</p>  <p>Time display.      Second digits flash.      Hour digits and "A" (for AM)/"P" (for PM) indicator flash.      Minute digits flash.</p> <p>Depress button "A".</p> <p>Day of the week flashes.      Language symbol flashes.      Date digits flash.      Month digits flash.</p> <p><b>Second Check</b> Check to see if the bulb lights up by depressing button "B".</p>  <p><b>Third Check</b></p>	