

SEIKO

DIGITAL QUARTZ

Cal. C359A

PARTS LIST

Cal. C359A

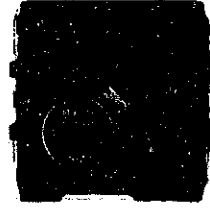
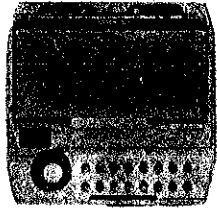

4001 590



4242 594

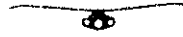

4245 590



4313 590

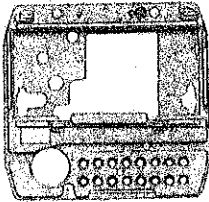

4398 590



4398 592

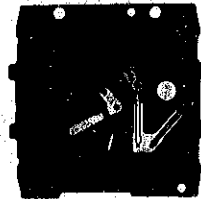

4410 590



☆ 4510 590

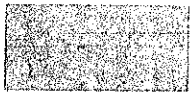

4521 700
4521 701



☆ 4530 649



4540 590



4580 590



4991 590



☆ Maxell SR926W

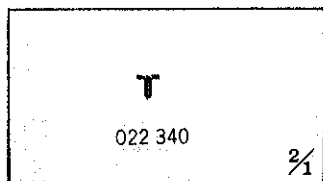

T
022 340

2/1

Cal. C359A

Characteristics

Casing diameter : 27.1 × 26.2 mm
 Maximum height : 5.9 mm without battery
 Frequency of quartz crystal oscillator : 32,768 Hz (Hz = Hertz Cycles per second)
 Time display : 12-hour Digital Display System showing hour, minute, second and day of the week.
 Calendar display : Digital Display System showing month, date, day of the week and "A"(AM) : "P"(PM).
 Calculator display : Digital Display System showing hour, minute and up to eight digits for the calculator with floating decimal point.
 Alarm display : Can be set to operate at any desired hour and minute.
 Time signal : It can be set to ring every hour on the hour.
 Display medium : Nematic Liquid Crystal, FM-Mode
 Regulation system : Trimmer condenser
 Illuminating light : Illuminates all the digital displays in the dark by depressing the light button.
 Battery life indicator : All the digits in the display begin flashing.

PART NO.	PART NAME	PART NO.	PART NAME
4001 590	Circuit block		
4242 594	Switch terminal		
4245 590	Switch spring		
4313 590	Connector		
4398 590	Liquid crystal panel frame		
4398 592	Speaker frame		
4410 590	Circuit cover		
☆4510 590	Liquid crystal panel		
4521 700	Reflecting mirror (Silver)		
4521 701	Reflecting mirror (Gold)		
☆4530 649	Bulb		
4540 590	Liquid crystal panel holder		
4580 590	Speaker block		
4991 590	Speaker gasket		
022 340	Liquid crystal panel holder screw		
022 340	Circuit block screw		
☆Maxell SR926W	Silver oxide battery		
☆U.C.C. 399			

Remarks :

Liquid crystal panel

☆4510 590 Be sure that the combination between the color of panel cover and liquid crystal panel should be matched according to the "SEIKO Quartz Casing Parts List".

Bulb

☆4530 649 The bulb replacement requires soldering a new bulb to the circuit. After soldering the bulb pins in position, cut off their excess parts.
 Refer to the "TECHNICAL GUIDE FOR CAL. C359A" for detail.

Battery

☆Maxell SR926W } The applied battery for this calibre might be added the substitutive in the future.
 ☆U.C.C. 399 } In that case, please refer to separate "BATTERIES FOR SEIKO QUARTZ BATTERIES".

☆⇔ Please see remarks.

Part numbers in light letters are not shown in photos.

TECHNICAL GUIDE

SEIKO DIGITAL QUARTZ

CAL. C359A

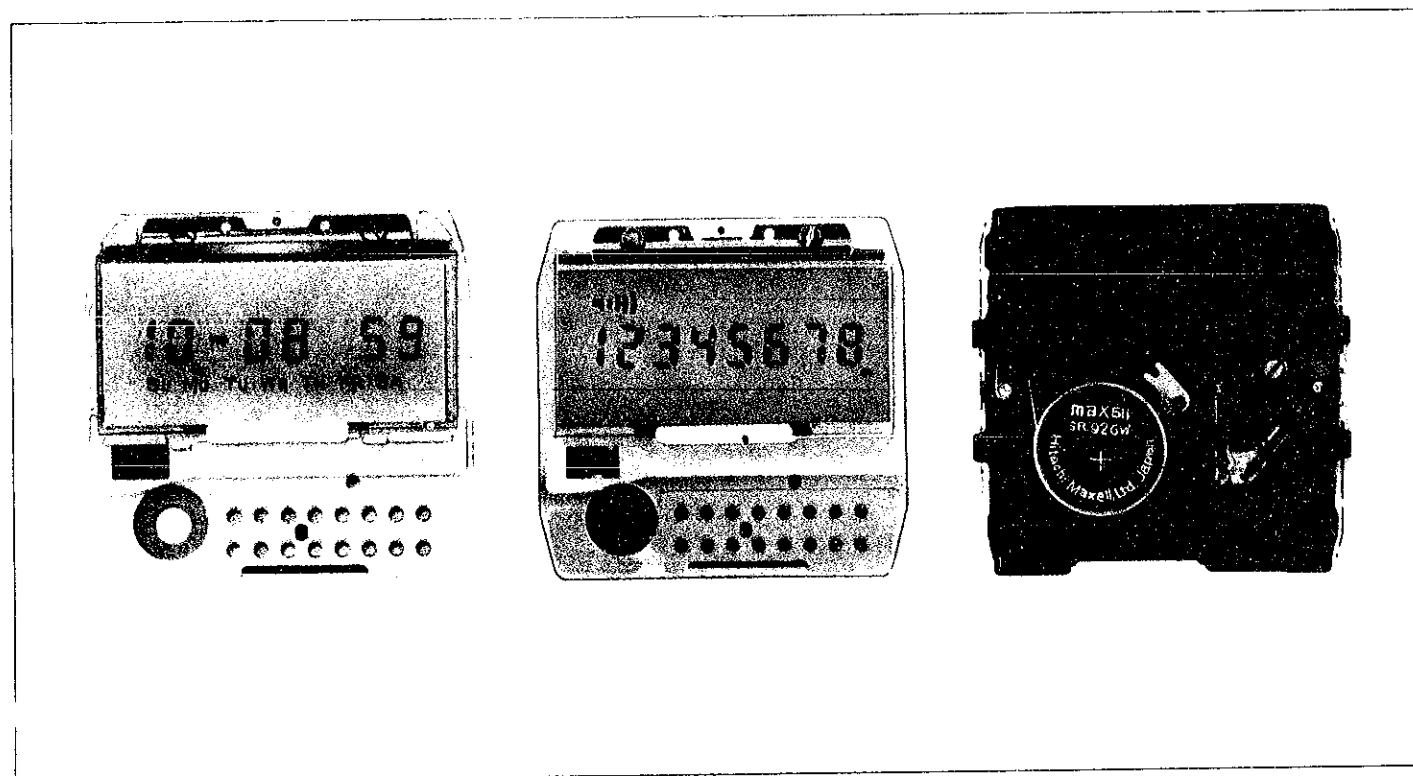

CONTENTS

I. SPECIFICATIONS	1
II. DISASSEMBLING, REASSEMBLING AND LUBRICATING	2
1. Disassembling and reassembling of the case	2
2. Disassembling, reassembling and lubricating of the module	6
III. CHECKING AND ADJUSTMENT	9
1. Guide table for checking and adjustment	9
2. Relationship between the segment (Liquid Crystal Panel Electrode) and C-MOS-LSI output terminal	10
3. Procedures for checking and adjustment	12
A: Check battery voltage	12
• How to check battery electrolyte leakage and repair	12
• Check pattern segment checking system	13
B: Check conductivity of liquid crystal panel ~ circuit block	14
C: Check liquid crystal panel and circuit block	15
D: Check current consumption	17
E: Check accuracy	18
F: Check functioning and adjustment	19
G: Check calculator function	20
H: Check speaker block	21
I: Check bulb condition	23
• How to replace the bulb	23
J: Check conductivity of switch components	24

I. SPECIFICATIONS

Item	Cal. No.
	C 359A
Display medium	Nematic Liquid Crystal, FEM (Field Effect Mode)
Display system	<p>Four-function changeover system with time, calculator, alarm setting function, and time and calendar setting function.</p> <ul style="list-style-type: none"> ● Time and calendar display Digital display system showing hour, minute, second and day of the week (constantly). In the time function, calendar and time set for the alarm are displayed by depressing a button. Calendar: Digital display system showing month, date, day of the week and "A" (for A.M.)/"P" (for P.M.). Time set for the alarm: Digital display system showing hour, minute and "A" (for A.M.)/"P" (for P.M.). ● Calculator function Arithmetic operations and % calculation up to 8 digits, -- and E (with floating decimal point). ● Alarm setting function Hour, minute, "A" (A.M.)/"P" (P.M.). Alarm time can be set to operate at any desired hour, minute and "A" (A.M.)/"P" (P.M.). ● Time and calendar setting function: Setting of the second, minute, hour ("A" (A.M.)/"P" (P.M.)), date, month and day of the week.
Calculator function	Addition, subtraction, multiplication, division, mixed calculation, constant calculation, raising numbers to a power, reciprocals, add on and discount percentage, overflow calculation and rough calculation.
Additional mechanism	<ul style="list-style-type: none"> ● Time signal: It can be set to ring every hour on the hour. ● Pattern segment checking system (also transmits the signal for measuring the daily rate.) ● Illuminating light: Illuminates the display in the dark. ● Battery life indicator: All the digits in the display start flashing when the battery life nears its end. ● Alarm test system
Crystal oscillator	32,768 Hz (Hz = Hertz Cycles per second)
Loss/gain	Loss/gain at normal temperature range Mean monthly rate: less than 10 seconds (Annual rate: less than 2 minutes)
Movement size	27.1 mm (between 3 o'clock and 9 o'clock sides) 26.2 mm (between 12 o'clock and 6 o'clock sides)
Height	5.9 mm without battery
Operational temperature range	Watch: -10°C ~ +60°C (14°F ~ 140°F) Calculator: 0°C ~ +60°C (32°F ~ 140°F)
Regulation system	Trimmer condenser
Battery	Silver oxide battery (Maxell SR926W or U.C.C.399) Voltage: 1.55 V Battery life is approximately 2 years.
I C (Integrated circuit)	C-MOS-LSI 1 unit

II. DISASSEMBLING, REASSEMBLING AND LUBRICATING

1. Disassembling and reassembling of the case

Disassembling procedures Figs.: ① ~ ⑥

Reassembling procedures Figs.: ⑥ ~ ①

Lubricating: Silicone grease 500,000 c.s.
Normal quantity ●▶

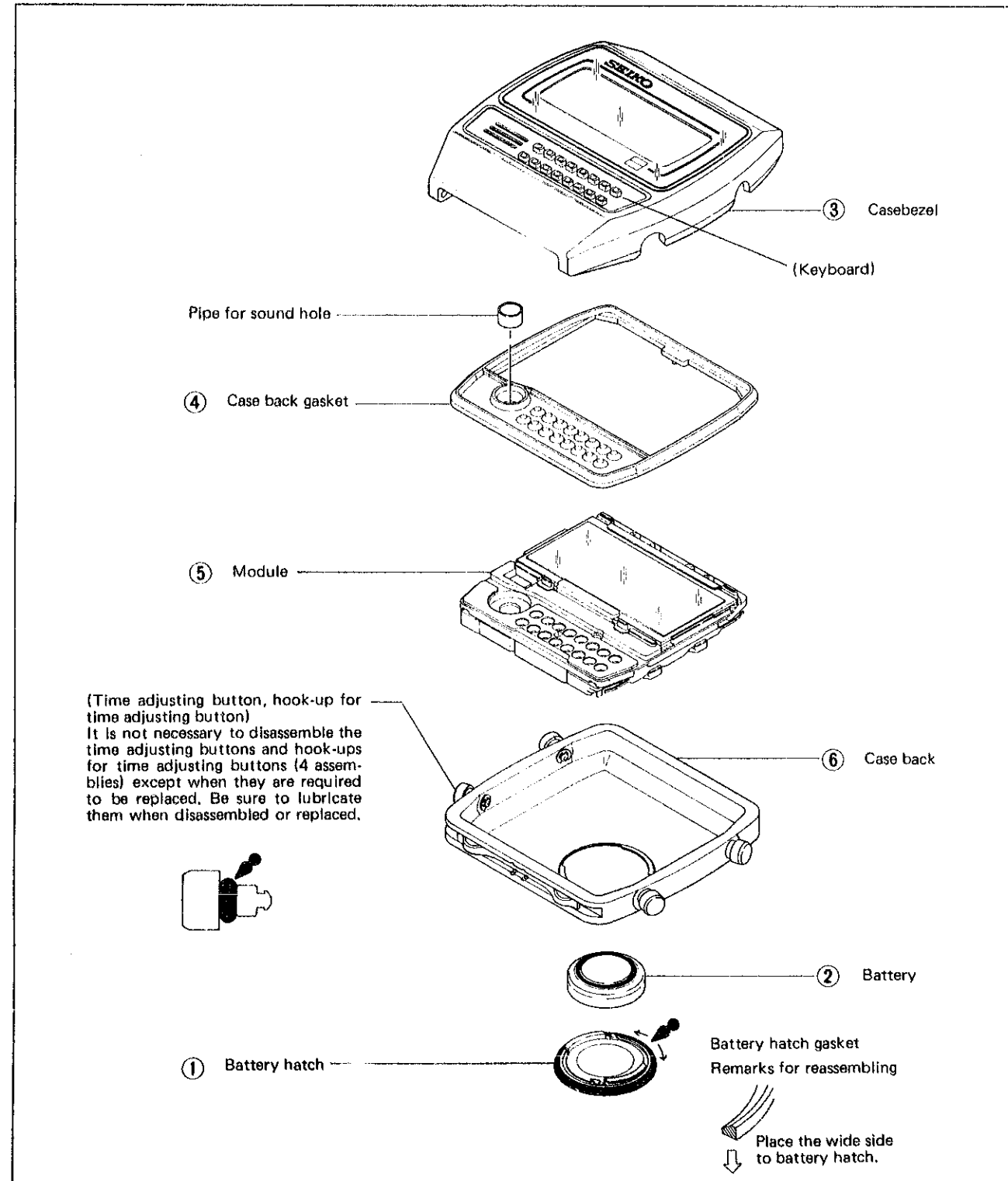

Glass portion and keyboard portion

It is not necessary to disassemble the glass portion and the keyboard portion except when the parts are replaced. (Refer to pages 4 and 5 to handle them.)

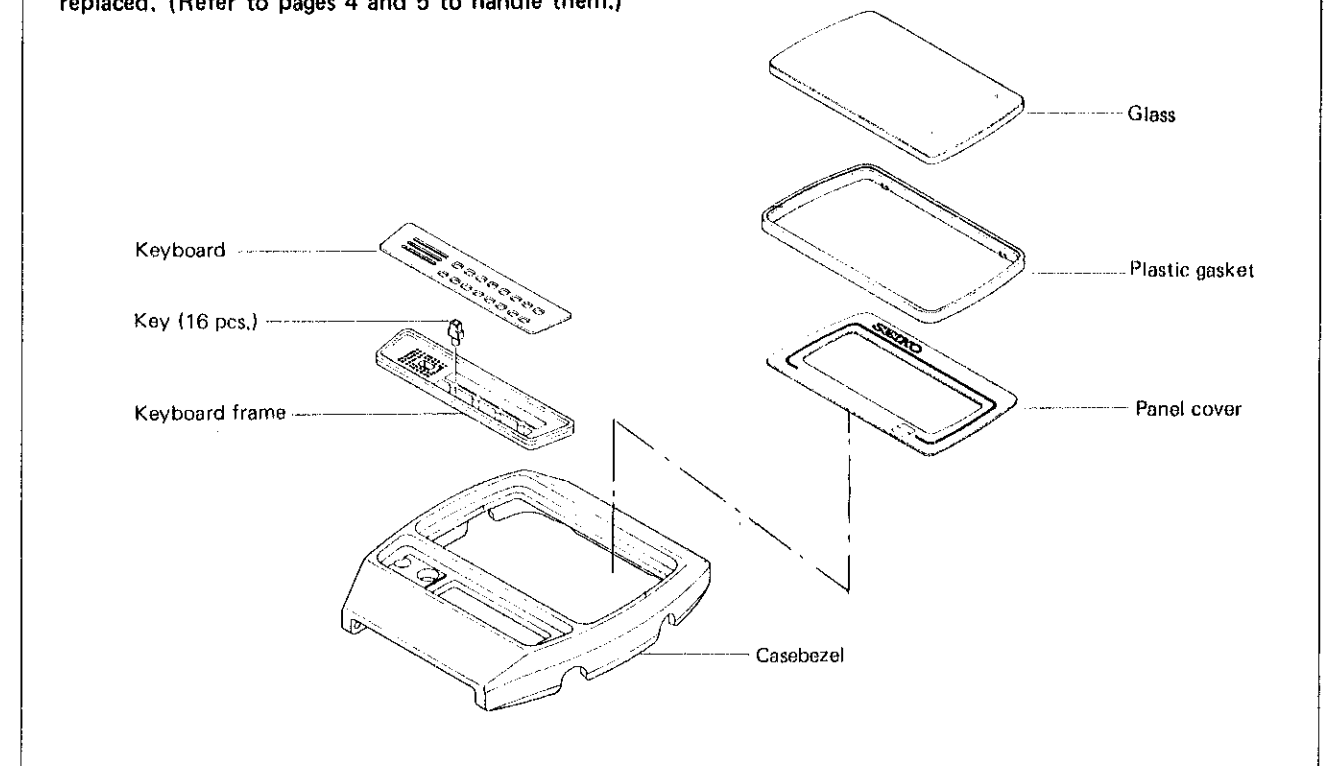

Remarks for reassembling

⑥ Case back

- Before reassembling the module, pull out all buttons so that switch springs do not prevent the module from being reassembled. (Push the buttons from inside with tweezers.)

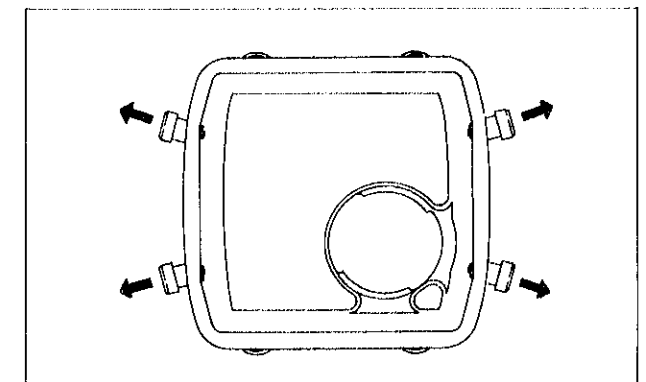

③ Casebezel

- 1) Set the casebezel with the notch of the button portion fitted to the button of the case back.
- 2) Be sure to snap the case back closed to the casebezel with the finger as shown in the illustration on the right.

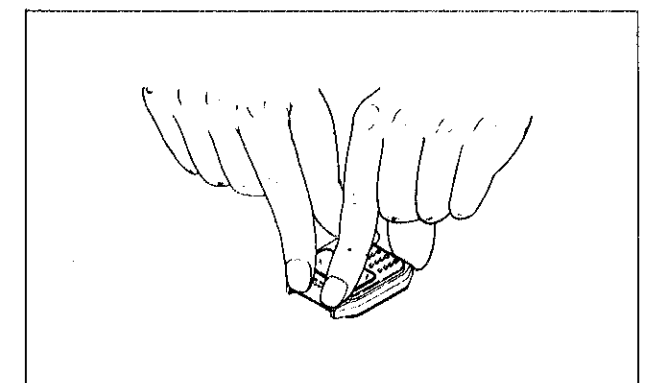

How to replace the glass

(It is not necessary to replace the glass except when the glass and panel cover are required to be replaced.)

● How to disassemble the glass

- Place a chamois sheet inside the casebezel and remove the glass from inside by pushing with a finger.
- When the glass cannot be removed with the finger, push it with the SEIKO tightening tool (S-220).
(Inserting disk : Inserting disk (S-161))
(Supporting disk: $\phi 32.0$ mm)
- Place a vinyl sheet between the casebezel and the supporting disk as shown in the illustration on the right.
- Push the panel cover and glass together from inside and remove it.

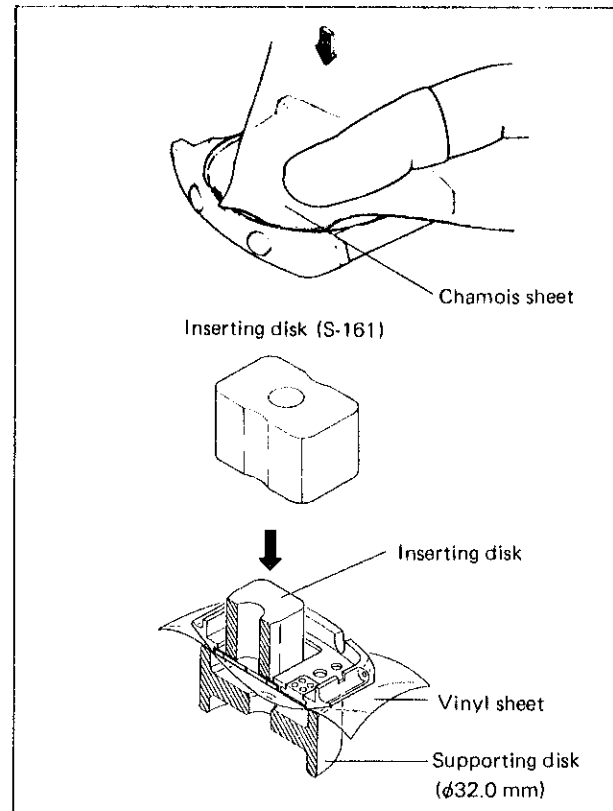

● How to reassemble the glass

- Set the plastic gasket.
 - Be sure to replace the plastic gasket with a new one in order to maintain water resistance.
 - Be careful not to mistake the upper side for the lower side.
- Reassemble the panel cover.
 - Be sure to set the backside of the panel cover close to the casebezel.
 - Be sure that the space between the casebezel and the edge of the panel cover is uniform in width.
- Place the glass.
 - Be careful not to mistake the upper side for the lower side. Place the wide bevel side down.
- Push in the glass (by using S-220).
(Inserting disk : Plastic inserting disk (S-173))
(Supporting disk: $\phi 18.0$ mm)
 - Be sure to push in the glass so as not to push up the keys with the supporting disk.

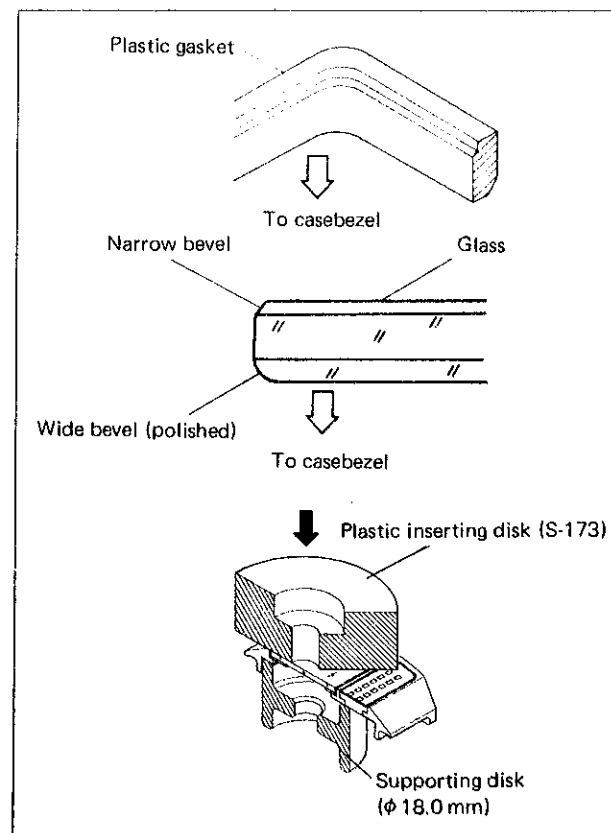

How to replace the keyboard portion

(It is not necessary to disassemble the keyboard portion except when it is required to be replaced.)

● How to disassemble the keyboard portion

Disassemble the keyboard portion with the SEIKO tightening tool (S-220).
(Inserting disk : Plastic inserting disk (S-162))
(Supporting disk: $\phi 30.0$ mm)

- Place a vinyl sheet between the casebezel and the supporting disk as shown in the illustration on the right.
- Push the keyboard portion with the inserting disk S-162 while holding the casebezel with the fingers.
- Be sure to push the keyboard portion gradually so as not to bend it.

● How to reassemble the keyboard portion

Push in the keyboard portion with the SEIKO tightening tool (S-220).
(Inserting disk : Inserting disk (S-173))
(Supporting disk: Select the one with the inside diameter of about 30.0 mm.)

- Set the keyboard portion horizontally.
- Be careful not to push it in at a stretch, and be sure to push it in gradually.

How to replace the keyboard, key and keyboard frame

(It is not necessary to disassemble the keyboard, key and keyboard frame except when they are required to be replaced.)

● How to disassemble the keyboard portion

Hold the keyboard portion with the finger as shown in the illustration on the right and push down the keyboard frame at its edge with the nail for disassembling.

● How to reassemble the keyboard portion

- Turn the keyboard over and set the key (16 pcs.) in the holes.
- Turn the keyboard frame over, place it on the keyboard and push it with the finger as shown in the illustration on the right.

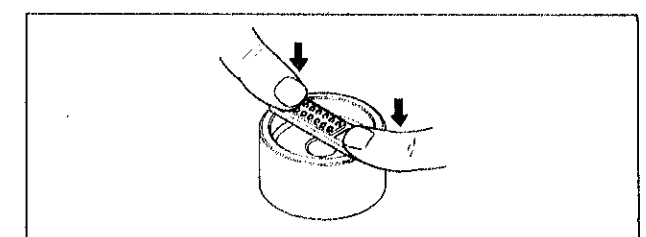
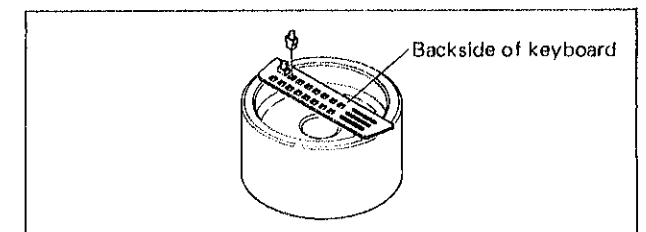
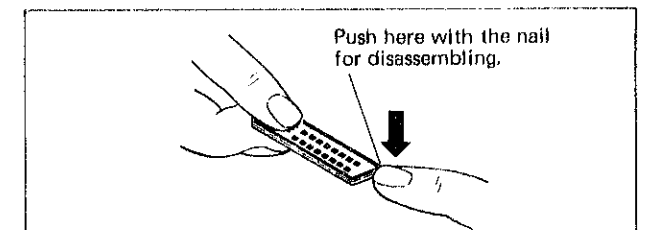
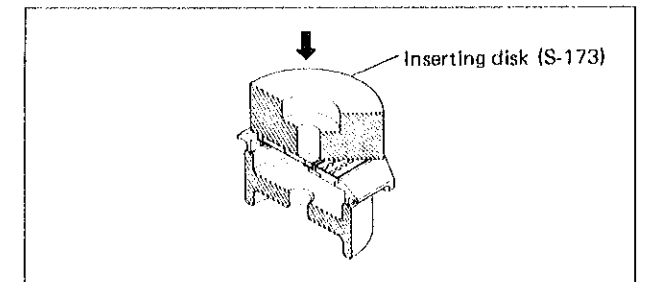
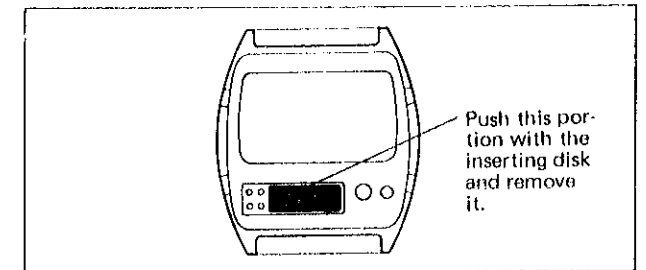
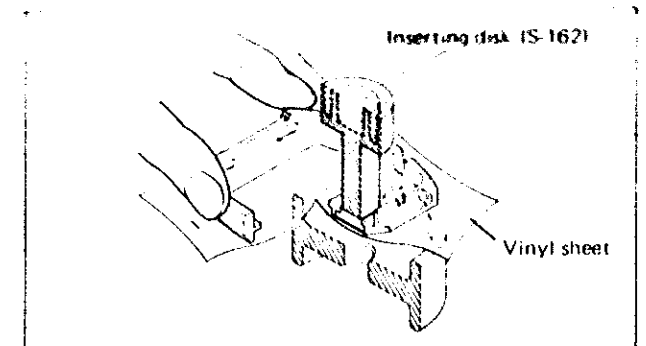

2. Disassembling, reassembling and lubricating of the module

Disassembling procedures Figs.: 1 ~ 12

Reassembling procedures Figs.: 12 ~ 1

Lubricating: Silicone grease 500,000 c.s.

Silicone grease 500,000 c.s.

Normal quantity 

The screws used are interchangeable each other.

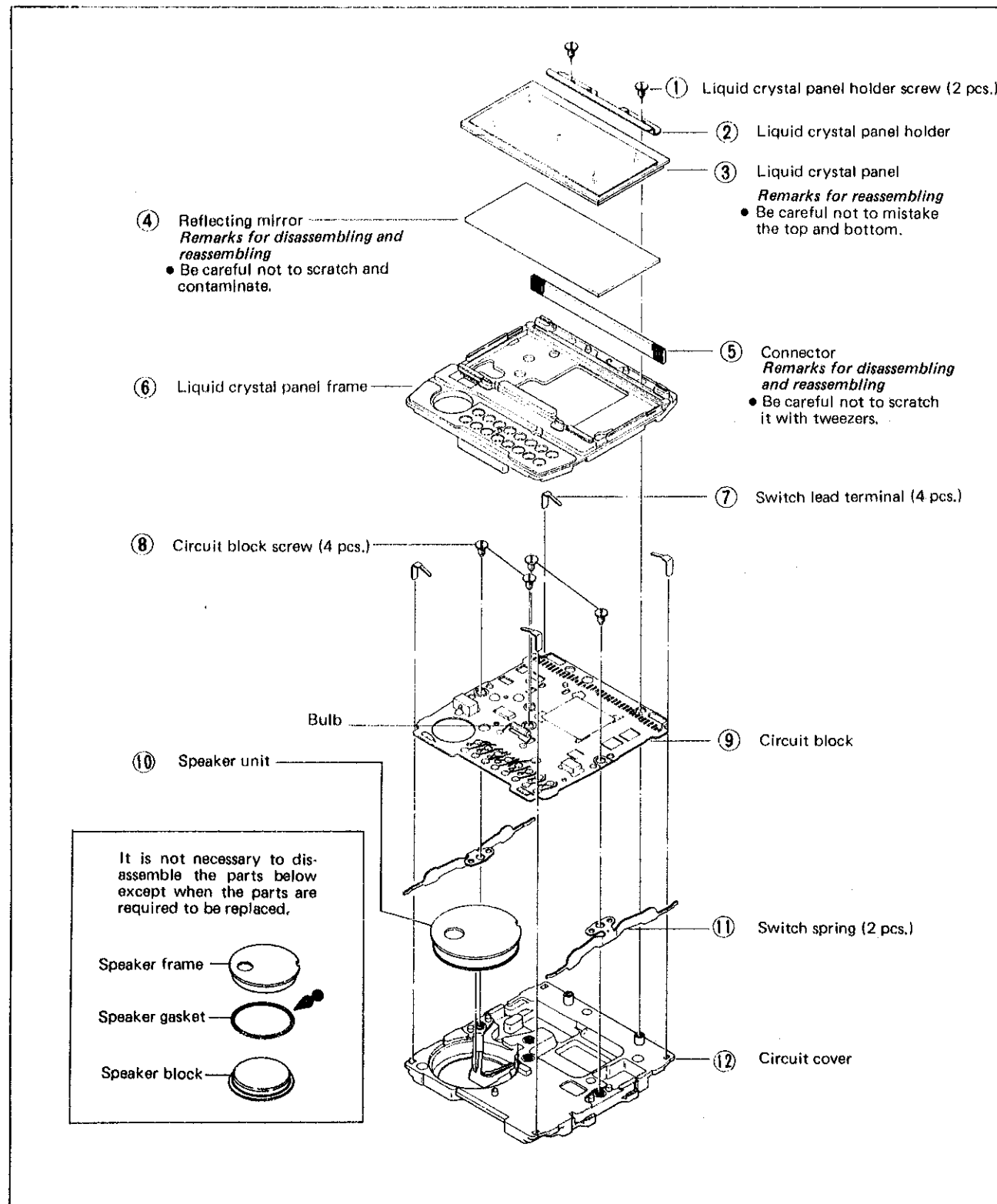

Remarks for disassembling

10 Speaker unit

- Pry up the speaker unit at its outer circumference with the tip of a screwdriver. Be careful not to put the tips of tweezers into the sound hole. (When reassembling the speaker unit, place the notch to stop turning to the notch of the circuit cover.)

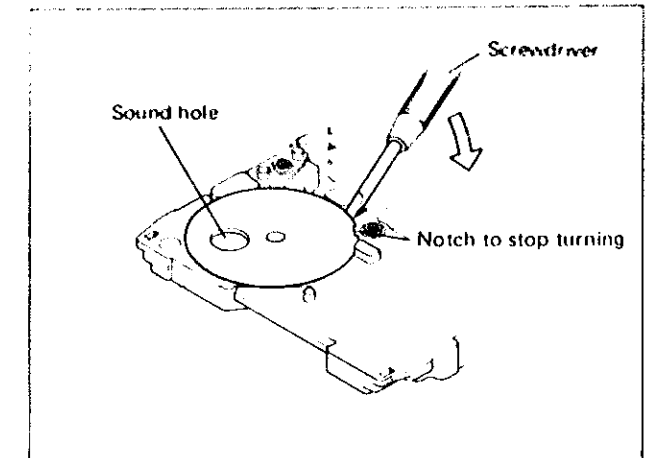

Remarks for reassembling

⑪ Switch spring (2 pcs.)

- Set the switch springs in place as shown in the illustration on the right.

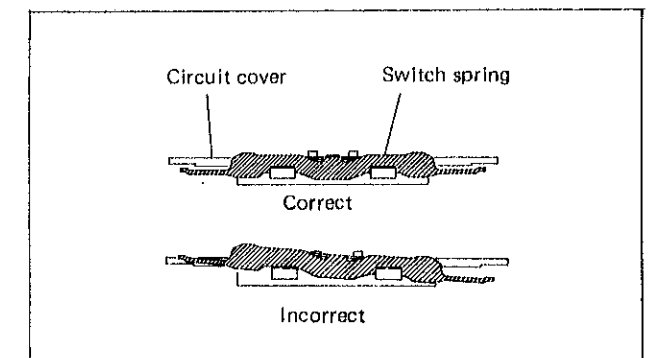

⑦ Switch lead terminal (4 pcs.)

- Be sure to reassemble the switch lead terminal correctly as shown in the illustration on the right.
- Be careful not to bend it.

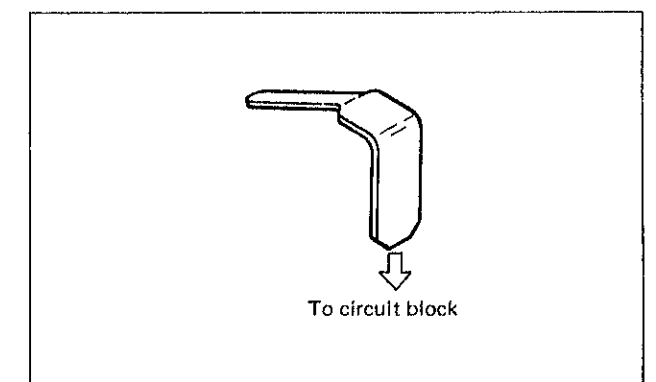

⑥ Liquid crystal panel frame

- Set the liquid crystal panel frame in place and push it from above.

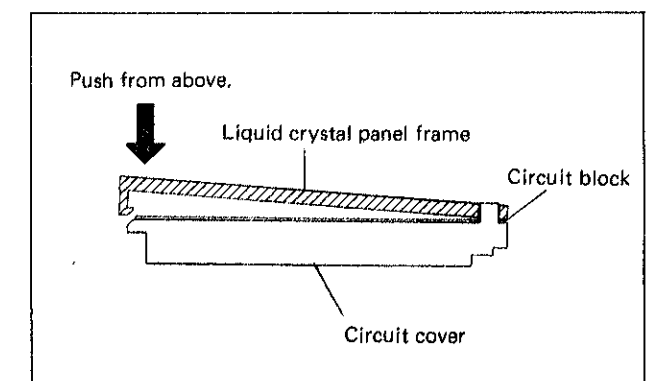

Disassembling and reassembling of the speaker unit

(It is not necessary to disassemble the speaker unit except when the parts are replaced.)

● **How to disassemble the speaker unit**

Remove the speaker block from the speaker frame by pulling the speaker unit lightly with the fingers as shown in the illustration on the right.

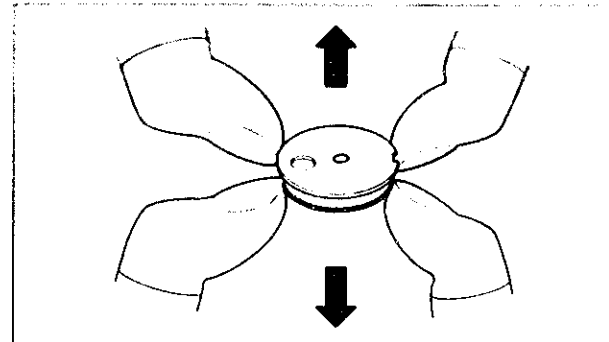

● **How to reassemble the speaker unit**

- i) Turn the speaker frame over and reassemble the speaker gasket in place.
- ii) Turn the speaker block over and push it in to the speaker frame with the finger.
Be sure to fit the arrow mark of the speaker block to the notch to stop turning.

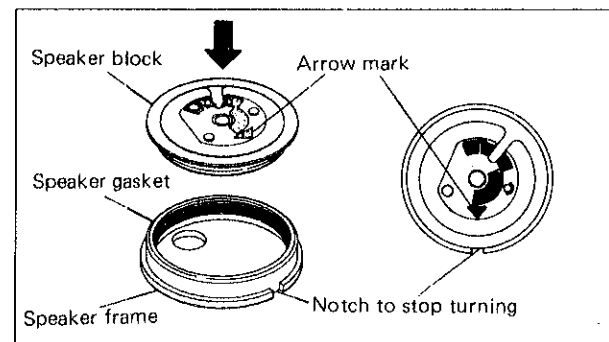

III. CHECKING AND ADJUSTMENT

Be sure to use the Static electricity protector (S-830) when handling the module.

1. Guide table for checking and adjustment

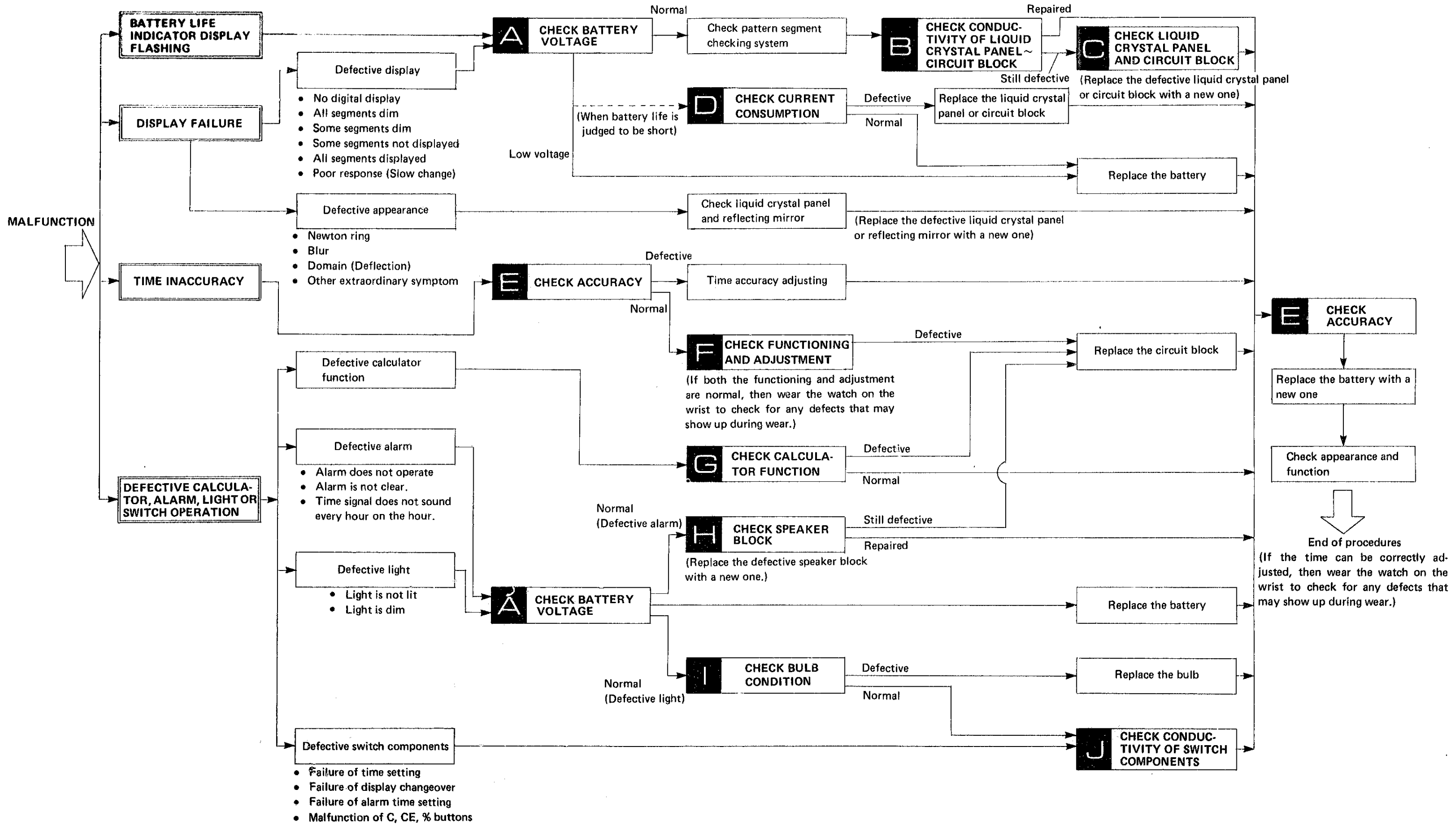

2. Relationship between the segment (Liquid Crystal Panel Electrode) and C-MOS-LSI output terminal

A complete knowledge of how the segment (Liquid Crystal Panel Electrode) works with the C-MOS-LSI output terminal will provide the proper procedures for checking and adjustment.

• Designation of segment

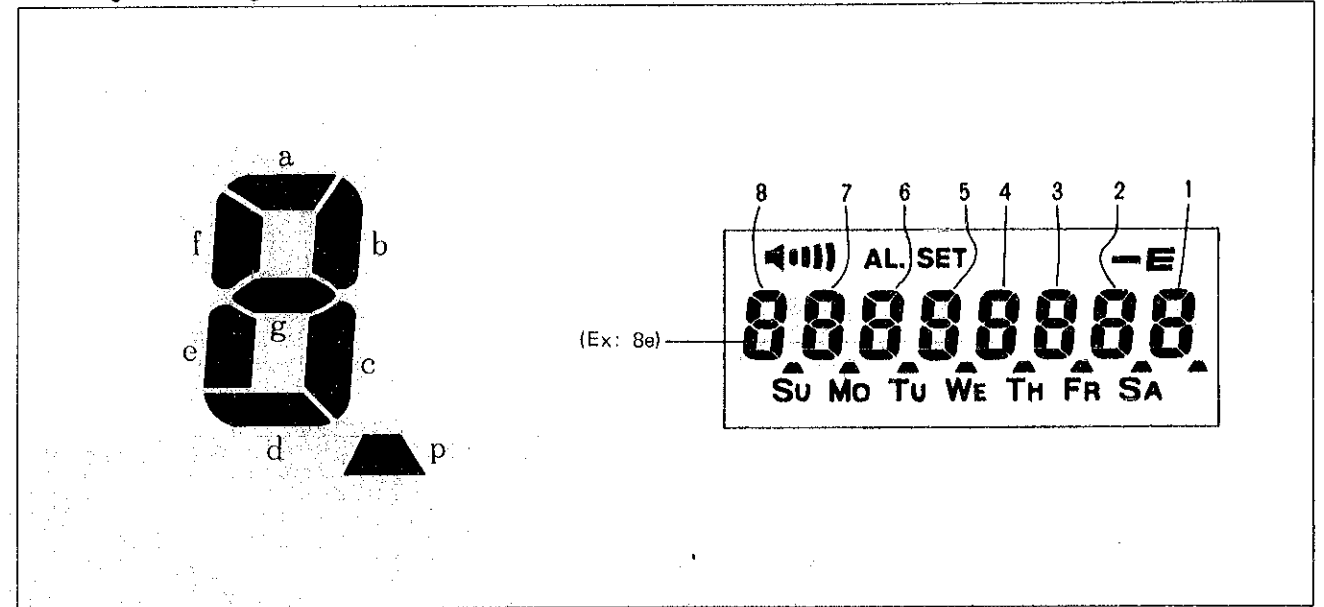

• Relationship between the segment and the C-MOS-LSI output terminal

Cal. C359A employs the multiplex driving system and is provided with a pair of common electrodes. (For further information on the multiplex driving system, refer to the "TECHNICAL GUIDE" for Cal. C153A.)

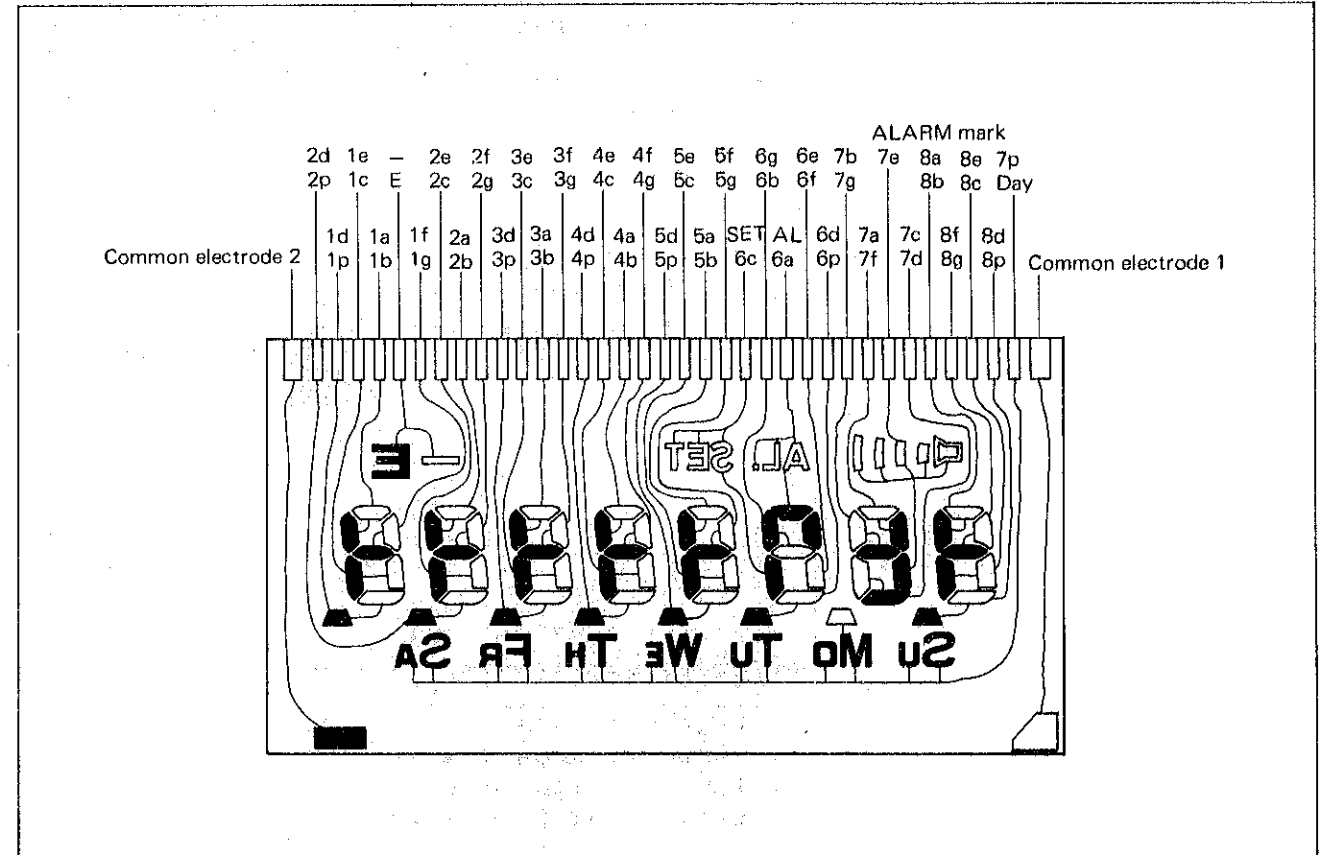

III. CHECKING AND ADJUSTMENT

1. Guide table for checking and adjustment

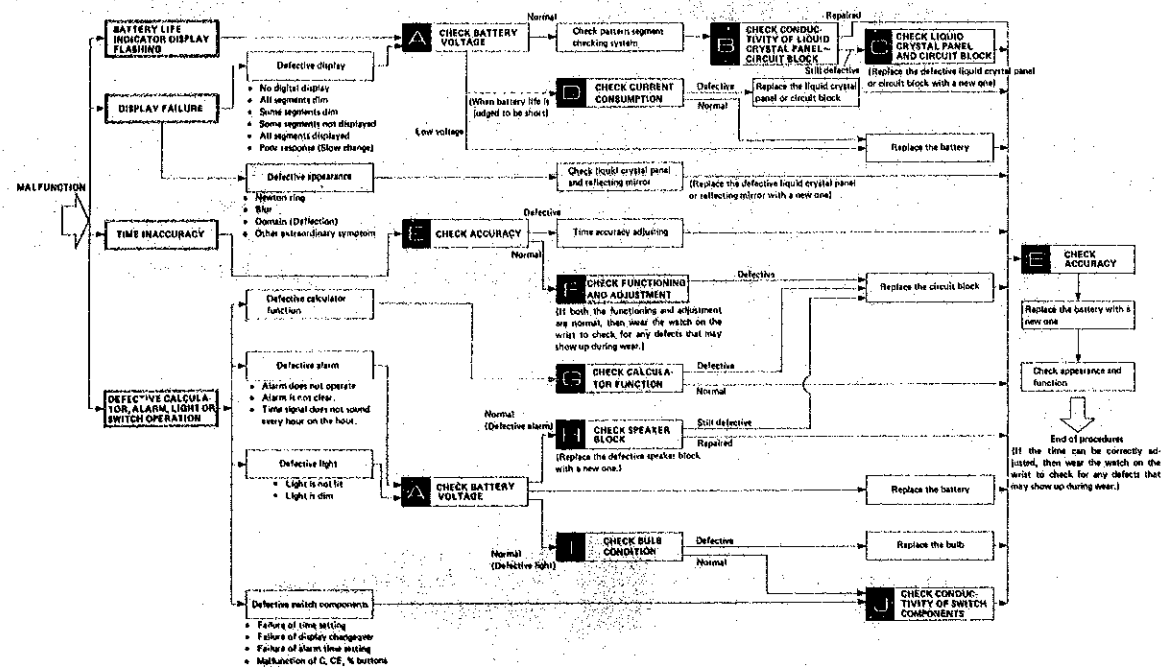

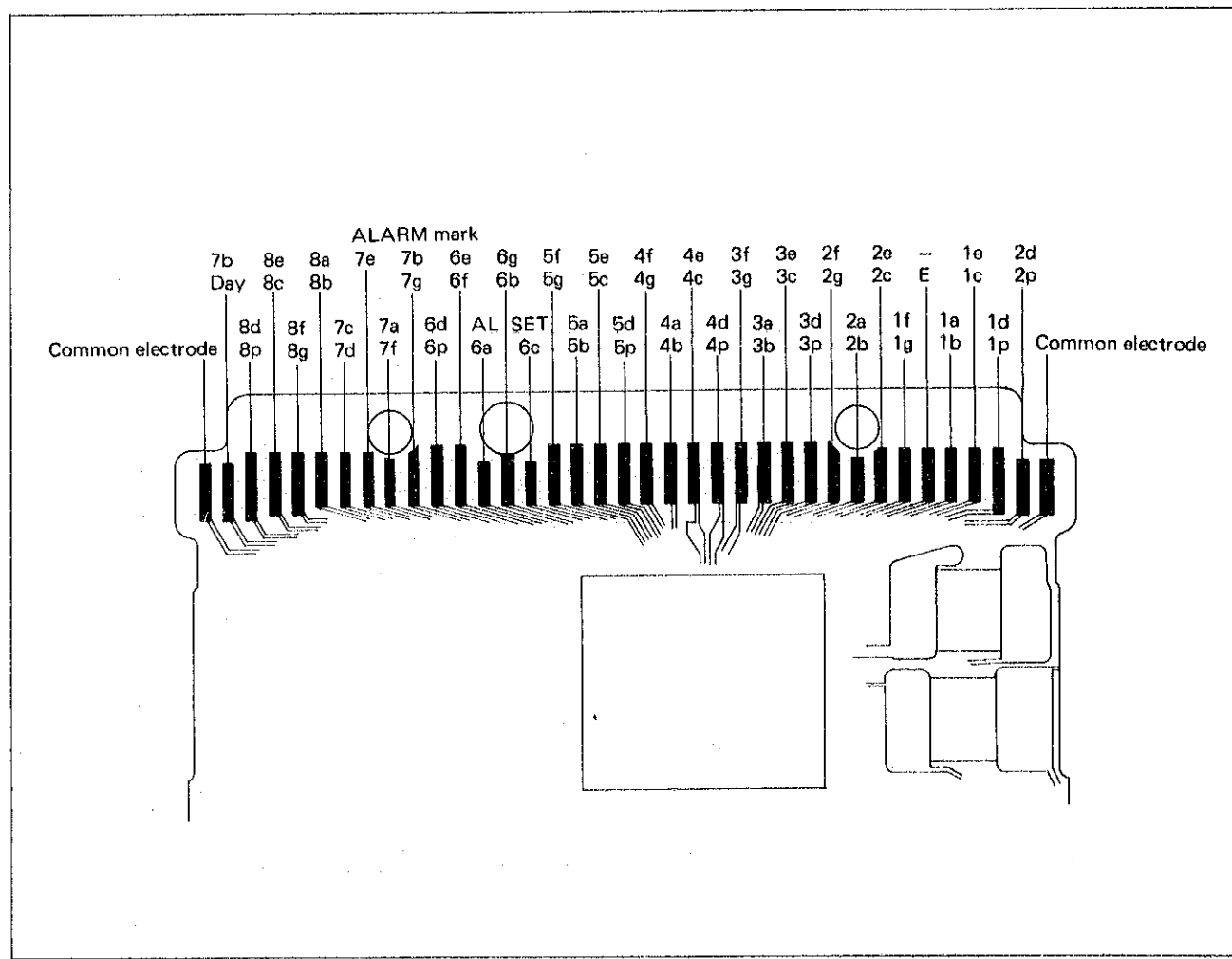

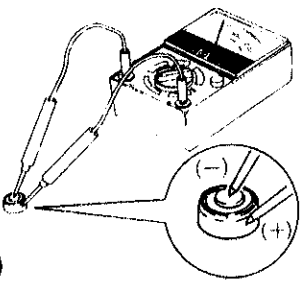
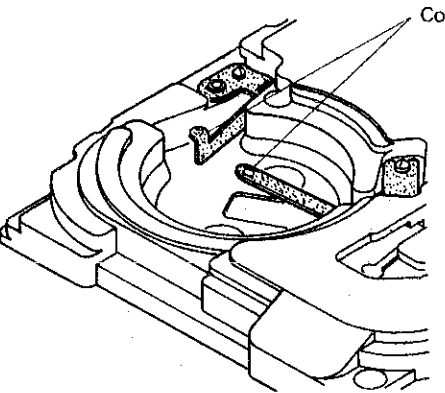

3. Procedures for checking and adjustment

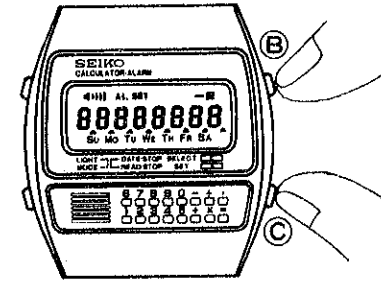
	Procedure	Result and Repair
CHECK BATTERY VOLTAGE	<p>Check to see if the battery voltage is normal.</p> <p>① Set up the Volt-ohm-meter. Range to be used: DC 3V</p>  <p>② Measuring</p> <ul style="list-style-type: none"> • Probe Red (+) Battery surface (+) • Probe Black (-) . . . Battery surface (-) <div style="border: 1px solid black; padding: 5px; margin-top: 10px;"> <p>When there is battery electrolyte leakage, refer to "HOW TO CHECK BATTERY ELECTROLYTE LEAKAGE AND REPAIR" below for repairing.</p> </div>	<p>More than 1.5V . . . Normal Less than 1.5V . . . Defective</p>
HOW TO CHECK BATTERY ELECTROLYTE LEAKAGE AND REPAIR	<ol style="list-style-type: none"> 1. Remove the module from the case bezel. 2. Disassemble the module. 3. Clean off battery electrolyte on the circuit cover, switch spring and switch lead terminal. <p>① Wipe off battery electrolyte with a brush moistened with distilled water. (If distilled water is not available, use tap water.) When the circuit block is cleaned, be sure to clean the connecting portions.</p>  <p>If the circuit block is badly contaminated with battery electrolyte, replace the circuit block with a new one. Example:</p> <ul style="list-style-type: none"> • When the circuit block is rusted. • When even the liquid crystal panel side is contaminated with battery electrolyte. <p>② Rinse with alcohol. ③ Dry with warm air by using a dryer.</p>	

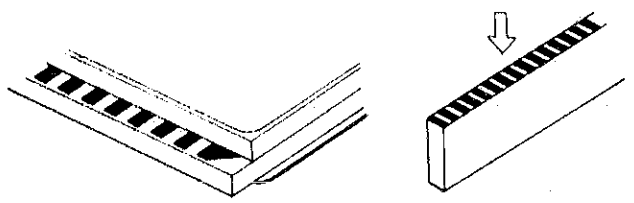
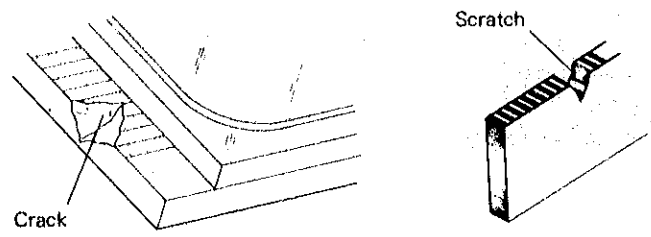
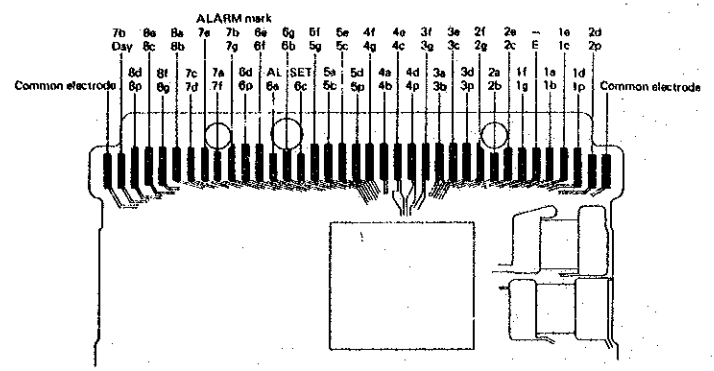

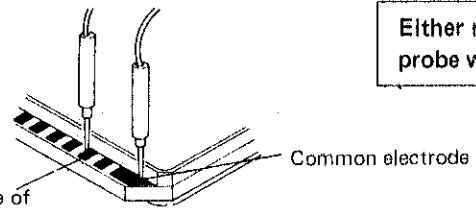
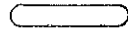

	Procedure	Result and Repair
HOW TO CHECK BATTERY ELECTROLYTE LEAKAGE AND REPAIR	<p>4. Wipe off battery electrolyte on the circuit block and speaker unit.</p> <p>① Wipe off battery electrolyte with a cloth moistened with distilled water. (If distilled water is not available, use tap water.)</p> <div style="border: 1px solid black; padding: 5px; margin-top: 10px;"> <p>Note:</p> <ul style="list-style-type: none"> • Do not expose the trimmer condenser to water or alcohol, and if it is exposed, there may be a change in the condenser capacity and eventually in the time accuracy. • Do not use a cloth which gives off lint such as gauze, flannel, etc. </div> <p>② Rinse with alcohol. (If the cleaned portions remain wet with water, they will corrode with rust.)</p> <p>③ Dry with warm air by using a dryer.</p> <p>5. Reassemble the module. Replace the battery with a new one.</p> <p>6. Check the time and calendar setting function and the current consumption.</p>	
CHECK PATTERN SEGMENT CHECKING SYSTEM	<p>If some segments are dead or dim, set the mode for the time and calendar setting function. Then depress buttons B and C together to find the defective segments. (If there is no defective segment, all segments light up.)</p> 	<p>Only one segment does not light up → Replace the liquid crystal panel. Two or more segments do not light up → Proceed to B.</p>

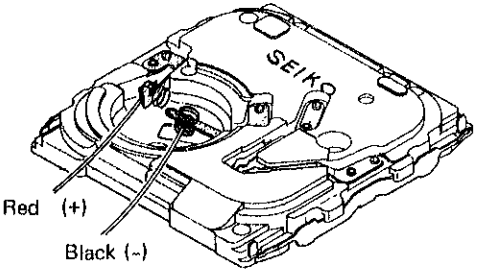
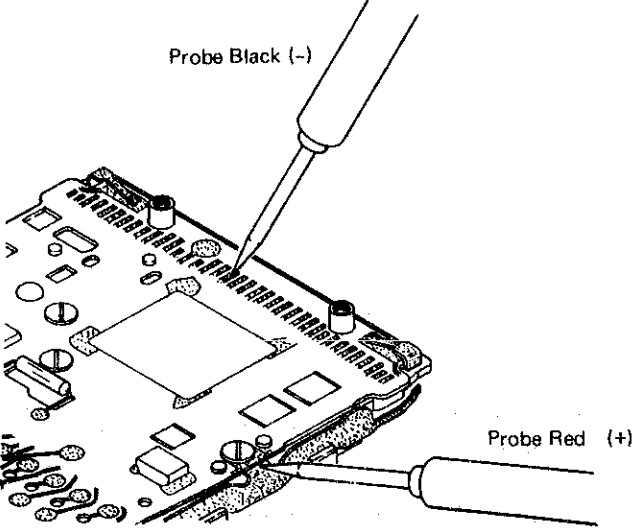
	Procedure	Result and Repair
B	<p>After removing the liquid crystal panel, check for poor conductivity of the liquid crystal panel, connector and segment (liquid crystal panel electrode) found to be defective in "CHECK PATTERN SEGMENT CHECKING SYSTEM". (Refer to the "Relationship between the segment and the C-MOS-LSI output terminal" on page 10.) Use a microscope for checking.</p> <p>(1) Check for dust, lint and other contamination on the liquid crystal panel electrodes and connectors.</p> <div style="text-align: center;"> <p>Be sure to check the connecting portion to the liquid crystal panel and the circuit block.</p>  </div> <p>(2) Check for any scratch, crack and break of the liquid crystal panel and connector.</p> <div style="text-align: center;">  </div> <p>(3) Check for any dust, lint and contamination on the output terminal of the circuit block.</p> <div style="text-align: center;">  </div>	<p>No dust, lint and contamination: Normal Proceed to B (2). Dust, lint and contamination: Defective Wipe off any foreign matter.</p> <p>No scratch, crack or break: Normal Proceed to B (3). Scratched, cracked or broken: Defective Replace the defective parts with new ones.</p> <p>No dust, lint and contamination: Normal Proceed to C. Dust, lint and contamination: Defective Wipe off any foreign matter.</p>

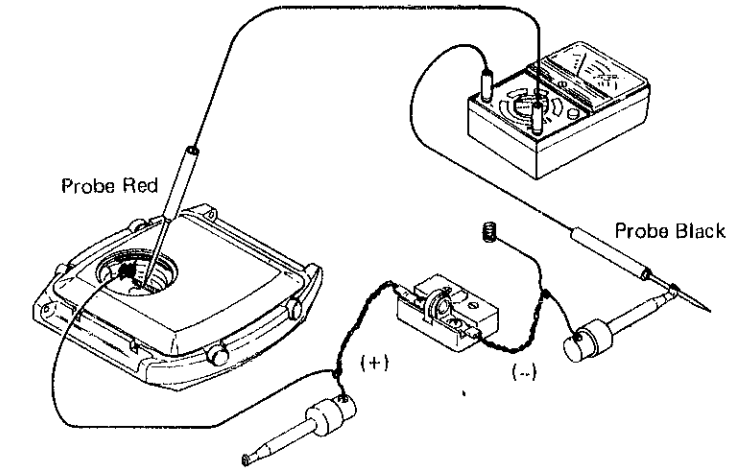
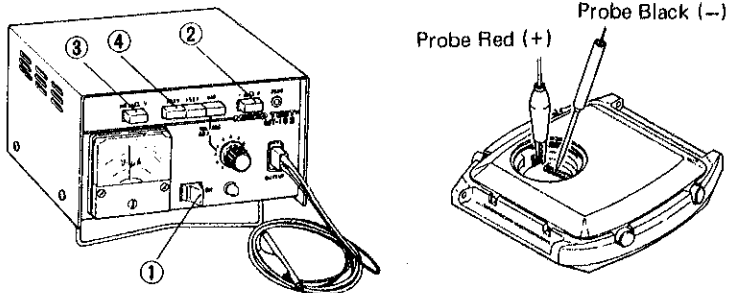
	Procedure	Result and Repair
C	<p>Check to see if the liquid crystal panel and the circuit block function correctly.</p> <p>1. How to check the liquid crystal panel</p> <p>① Set up the Volt-ohm-meter. Range to be used: OHMS R x 1 ~ R x 1K</p> <p>Note: Any range will do if more than 3V is applied to the terminal of the Volt-ohm-meter. If the output voltage of the Volt-ohm-meter is less than 3V in measuring, no segment may be lit. In this case, change the range to the one (R x 10K) which is higher in resistance.</p> <p>② Remove the liquid crystal panel from the module and turn it over.</p> <p>③ Measuring</p> <div style="text-align: center;">  <p>Either red or black probe will do.</p> <p>Electrode of defective segment</p> <p>Common electrode</p> <p>(Either red or black probe must be applied to the common electrode.)</p> </div> <p>Note: The liquid crystal panel of Cal. C359A is provided with a pair of common electrodes as shown in the illustration for "Relationship between the segment and the C-MOS-LSI output terminal" on page 10. Each segment lights up by the potential between one of these two common electrodes. The combination of each segment and common electrodes 1 and 2 is distinguished individually as shown in the illustration on page 10.</p> <p>Common electrode 1  Common electrode 2 </p> <p><i>Checking example</i></p> <p>When the segments of 3a, 3b do not light up:</p> <ul style="list-style-type: none"> • Check to see if 3a is combined with the common electrode 1 and 3b is combined with the common electrode 2 according to the illustration on page 10. • Make sure of the position of the electrode corresponding to 3a, 3b and check to see if 3a lights up when each probe is applied to the electrodes corresponding to 3a, 3b and the common electrode 1 with the liquid crystal panel turned over. Also check to see if 3d lights up when each probe is applied to the electrodes corresponding to 3a, 3b and the common electrode 2. 	<p>Lights up: Normal Proceed to C (2). Does not light up: Defective Replace the liquid crystal panel.</p>

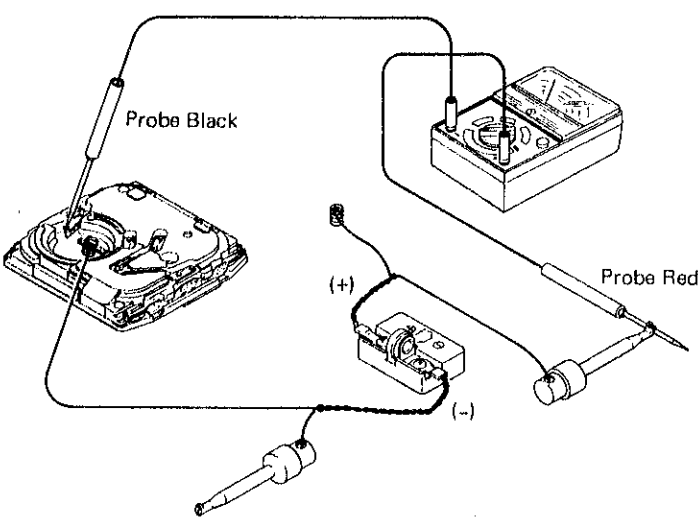
Procedure	Result and Repair
<p>2. How to check the output voltage of the circuit block</p> <p>① Set up the Volt-ohm-meter. Range to be used: DC 3V</p> <p>② Disassemble the module from ① liquid crystal panel holder screw up to ⑥ liquid crystal panel frame on page 6.</p> <p>③ Supply the current to the module.</p> <ul style="list-style-type: none"> Use the Current supplier (S-833) as shown in the illustration.  <p>④ Measuring Probe Red (+) . . . Switch spring Probe Black (-) . . . One of the output terminals of the circuit block (If some displays are defective, apply to the corresponding output terminals of the circuit block.)</p> 	<p>More than 0.8V: Normal (All the terminals must be more than 0.8V.) Return to B.</p> <p>Less than 0.8V: Defective Replace the circuit block.</p>

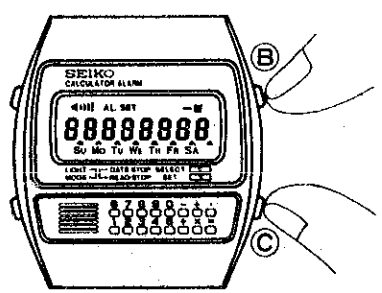
Procedure	Result and Repair
<p>D Check to see if the current consumption is normal. Be sure to check the current consumption in any other function than the calculator display function.</p> <p>1. Check the total current consumption of the watch.</p> <ul style="list-style-type: none"> Volt-ohm-meter Range to be used: DC 12 μA (DC 0.03 mA)* Use the Current supplier (S-833) and connect as shown in the illustration below.  <p>① Power switch: ON ② Polarity changeover button: + ③ Current consumption/Voltage indication button: μA ④ Voltage selection button: 1.55V Probe Black (-): Battery connection Clip Red (+): Plus terminal of battery connection</p> 	<p>* Note: If the pointer of the Volt-ohm-meter swings over the maximum value when DC 12 μA or 0.03 mA is used, change a range to a greater one where the pointer does not run over the maximum value while applying the probes to the respective portions. Then, after two or three seconds, return the range to DC 12 μA or 0.03 mA again for measuring.</p> <p>Less than 2.0μA: Normal Replace the battery with a new one. More than 2.0μA: Defective Proceed to D 2.</p> <p>Note: When measuring the current consumption in the calculator function, the value indicated will be approx. 20 times that obtained in the time function.</p> <p>Remarks: If the pointer of the Micro Test swings over the maximum value while the current consumption is measured, depress the Current consumption/Voltage indication button ③ so that it is released to indicate the voltage (1.5 V) while the black probe and the red clip are applied. Then, after two or three seconds, depress the Current consumption/Voltage indication button again so that it holds in the pushed-in position (μA) to indicate the current consumption for measuring.</p>

	Procedure	Result and Repair
CHECK CURRENT CONSUMPTION	<p>2. Check the current consumption only for the circuit block (with the liquid crystal panel removed).</p> <p>Follow the same procedures as in  1.</p> <p>Connect the Current supplier (S-833) as shown in the illustration below.</p> 	<p>Less than $2.0\mu\text{A}$: Normal Replace the liquid crystal panel.</p> <p>More than $2.0\mu\text{A}$: Defective Replace the circuit block.</p>
CHECK ACCURACY	<p>Check gain and loss of time.</p> <p>(1) Set up the Quartz Tester. As there are several types of Quartz Testers, refer to the respective instruction manuals for handling.</p> <p>(2) Set the mode for the time and calendar setting function, then depress the buttons  and  together, and all the segments light up.</p>  <p>After the buttons  and  are depressed, the alarm rings every one second.</p>	

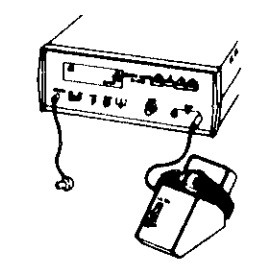
	Procedure	Result and Repair
CHECK ACCURACY	<p>(3) Measuring While the alarm rings every one second, there is generated magnetism from the speaker coil. Therefore, the electromagnetic microphone (for analogue quartz watches) can be used for measuring gain and loss of time. (But the every-one-second signal stops in 1 ~ 2 minutes. Repeat the same procedures.)</p>  <p>Time accuracy can also be measured with the electric-field detection microphone in the same manner as for the existing liquid crystal watches.</p>	<p>Does not lose or gain: Normal Proceed to the following procedure.</p> <p>Loses or gains: Defective Proceed to [Time accuracy adjusting]. Time accuracy is adjusted by turning the trimmer condenser.</p>
CHECK FUNCTIONING AND ADJUSTMENT	<p>Check functioning and adjustment by operating the buttons.</p> <p>(1) Check the alarm time setting function. Set the hour and minute more than one cycle and check to see if the digits are advancing correctly.</p> <p>(2) Check the time and calendar setting function. Set the time and calendar digits more than one cycle for each unit and check to see if each digit is advancing correctly.</p>	<p>Functions correctly and can be adjusted: Normal Wear the watch on the wrist to check time accuracy.</p> <p>Does not function correctly or cannot be adjusted: Defective Replace the circuit block.</p>

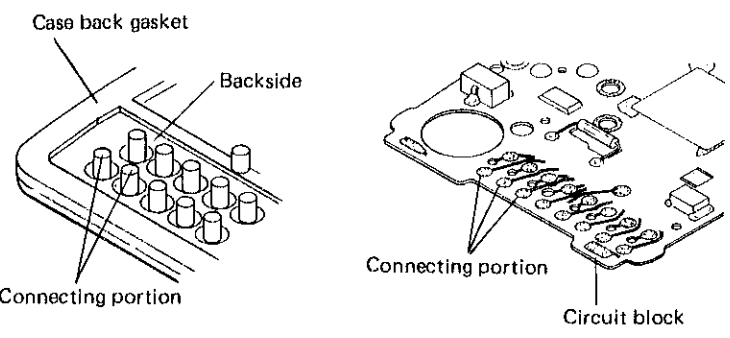
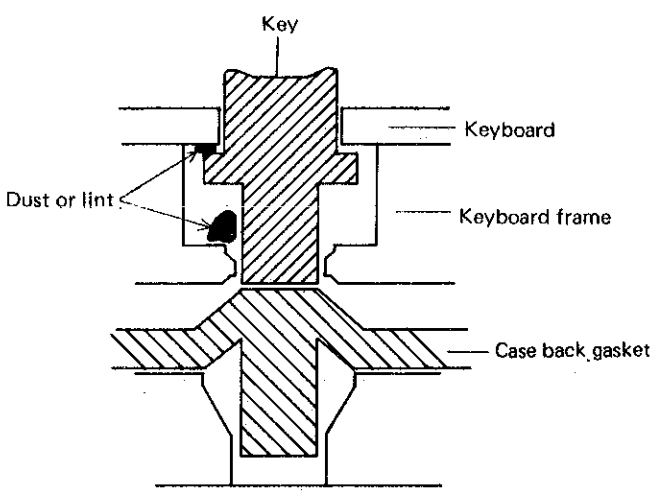
G	Procedure	Result and Repair				
	<p>Check to see if the calculator function is normal.</p> <p>1. Check to see if the answer is correct by operating the keys in the sequence below.</p> <table border="0" data-bbox="237 441 742 546"> <tr> <td>Key operation</td> <td>Display</td> </tr> <tr> <td>3 [=] 8 [X] 1 [÷] 9 [=] 0.555555</td> <td></td> </tr> </table> <p>proceed</p> <p>[C] 7 [+] 6 [-] 5 [=] 8.</p> <p>proceed</p> <p>[+] 20 [%] [+] . 4 [=] 10.</p> <p>2. Check for dust, lint and contamination around the keys and on the contacting portion of the gasket for case back portion and the circuit block.</p>  	Key operation	Display	3 [=] 8 [X] 1 [÷] 9 [=] 0.555555		<p>Correct: Normal Incorrect: Defective Proceed to G 2.</p> <p>Uncontaminated: Normal</p> <p>When the calculator function is still defective after the case back gasket has been replaced with a new one. Replace the circuit block with a new one.</p> <p>Contaminated: Defective Wipe off any foreign matter.</p>
Key operation	Display					
3 [=] 8 [X] 1 [÷] 9 [=] 0.555555						

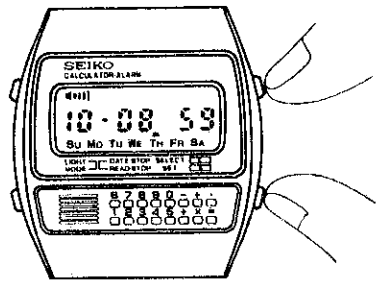
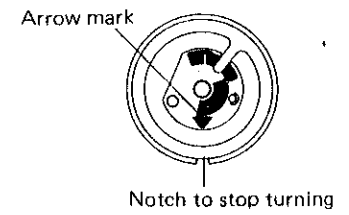
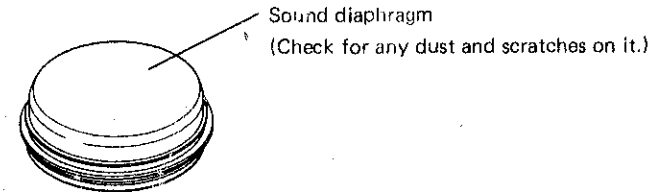
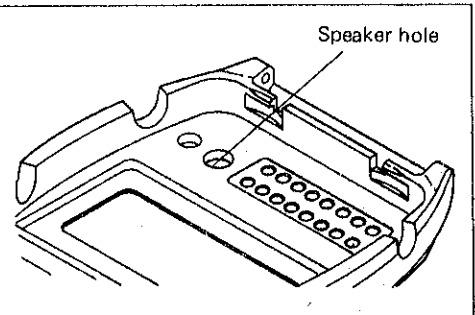
H	Procedure	Result and Repair
	<p>1. Check to see if the alarm operates correctly. Check to see if the alarm operates when the watch is in the time function by depressing the two buttons on the right side together.</p>  <p>2. Check to see if the arrow mark of the speaker block is fitted with the notch to stop turning of the speaker frame.</p>  <p>3. Check for any dust and scratches on the sound diaphragm of the speaker block.</p>  <p>Note: Make sure that the speaker hole is not clogged with dust.</p> 	<p>Alarm operates: Normal Set the alarm time again and if the alarm does not operate at the required time. Replace the circuit block. Alarm does not operate or operates but not clear: Defective Proceed to H 2.</p> <p>Fitted: Normal Proceed to H 3. Not fitted: Defective Fit it again.</p> <p>No dust and scratches: Normal Proceed to H 4.</p> <p>Dust: Defective Wipe off any foreign matter with a cloth moistened with cleaning solution. Scratched: Defective Replace the speaker block.</p>

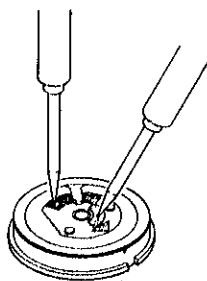
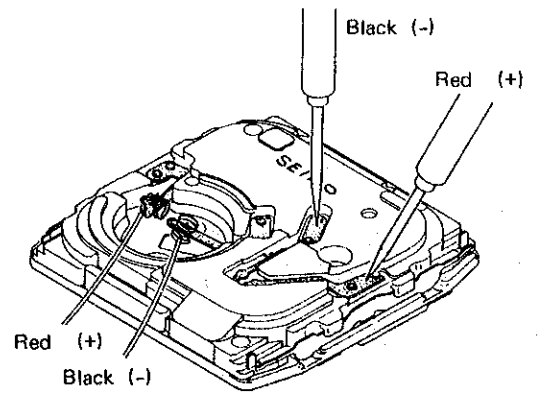
	Procedure	Result and Repair
CHECK SPEAKER BLOCK	<p>4. Check for any broken coil wire and short circuit of the coil of the speaker block.</p> <p>① Set up the Volt-ohm-meter. Range to be used: OHMS R x 1</p> <p>② Measuring Apply the probes of the Volt-ohm-meter to the lead terminal of the speaker block.</p>  <div data-bbox="498 682 934 798" style="border: 1px solid black; padding: 2px;"> <p>Note: Be careful not to break the coil wire when the probes are applied to the coil terminal.</p> </div>	<p>Resistance is: $30\Omega \sim 150\Omega$: Normal Proceed to H 5. Less than 30Ω or more than 150Ω: Defective Replace the speaker block.</p>
	<p>5. Check to see if the output signal of the circuit block is transmitted to operate the speaker block.</p> <p>① Reassemble the module.</p> <p>② Set up the Volt-ohm-meter. Range to be used: DC 3V</p> <p>③ Supply current to the module.</p> <ul style="list-style-type: none"> • Use the Current supplier (S-833). • Make the alarm ready for sounding by operating the switch spring. <p>④ Apply the probes of the Volt-ohm-meter to the speaker lead terminals of the circuit cover.</p> 	<p>Pointer swings two or four times every second: Normal Replace the speaker block.</p> <p>Pointer does not swing: Defective Replace the circuit block.</p>

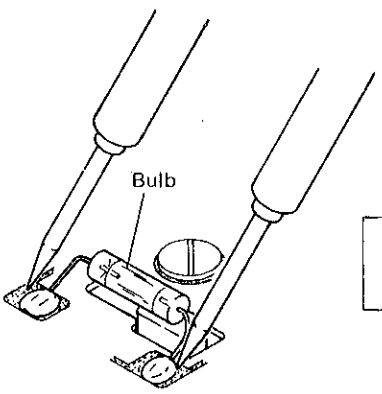
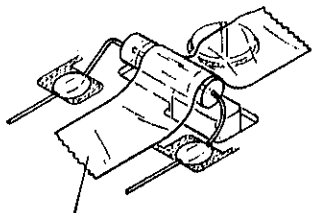
	Procedure	Result and Repair
CHECK BULB CONDITION	<p>Check to see if there is a broken filament in the bulb.</p> <p>(1) Set up the Volt-ohm-meter. Range to be used: OHMS R x 1</p> <p>(2) Measuring Apply the two probes of the Volt-ohm-meter to the bulb lead terminals as shown in the illustration.</p>  <div data-bbox="2101 745 2493 850" style="border: 1px solid black; padding: 2px;"> <p>Note: Either red or black probe will do.</p> </div>	<p>Bulb lights up: Normal Proceed to J.</p> <p>Bulb does not light up: Defective Replace the bulb with a new one.</p>
	HOW TO REPLACE THE BULB	<div data-bbox="1765 1018 2611 1155" style="border: 1px solid black; padding: 5px;"> <p>Be sure to use the soldering iron of low heat capacity with as fine a tip as possible. Thickness of the tip: approx. $\phi 1$ mm Heat capacity: 5 W ~ 20 W of power consumption</p> </div> <p>1. Remove the defective bulb. Hold the defective bulb gently with tweezers, apply the soldering iron to the bulb lead terminal and lift the lead of the bulb to remove it.</p> <p>2. Solder the new bulb. Be sure to solder the lead of the bulb securely with the circuit block reassembled to the circuit cover. In this case, fix the bulb to the circuit block with a cellophane adhesive tape, etc. It will make it easier to solder the bulb.</p>  <p>Cellophane adhesive tape</p> <p>3. The lead of the bulb is made somewhat longer. After soldering the bulb, cut it off properly with nippers.</p>

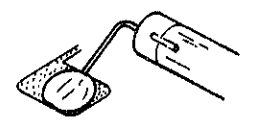
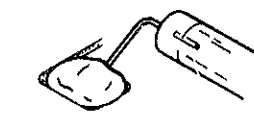
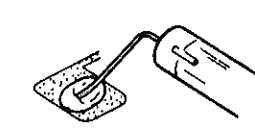
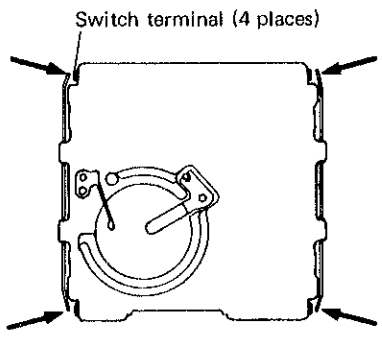
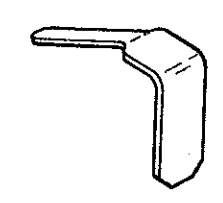
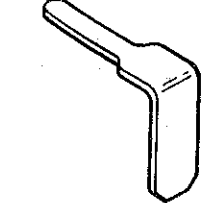
	Procedure	Result and Repair
HOW TO REPLACE THE BULB	<p>Note: If the soldering iron is applied too long, the circuit block may be damaged. Be sure to apply the soldering iron to such an extent that the solder is melted uniformly at the connection (for approx. 1 second).</p> <div style="display: flex; justify-content: space-around; align-items: flex-start;"> <div style="text-align: center;"> <p>Correct</p>  </div> <div style="text-align: center;"> <p>Excessive</p>  </div> <div style="text-align: center;"> <p>Insufficient</p>  </div> </div> <p>4. Finally check the bulb condition again.</p>	
CHECK CONDUCTIVITY OF SWITCH COMPONENTS	<p>1. Check to see if the switch springs (four arrow-marked portions shown in the illustration below) function correctly when they are pushed in.</p> <p>① Check to see if the four arrow-marked switch springs touch the switch terminals of the circuit block when they are pushed in with tweezers and that they do not touch the switch terminals of the circuit block when released.</p> <div style="text-align: center;">  </div> <p>② Check for dust, lint and other contamination on the contacting portions.</p> <p>2. Check to see if the switch terminal is deformed or not.</p> <div style="display: flex; justify-content: space-around; align-items: center;"> <div style="text-align: center;"> <p>Correct</p>  </div> <div style="text-align: center;"> <p>Incorrect</p>  </div> </div>	<p>Functions correctly: Normal Proceed to J (2).</p> <p>Does not function correctly: Defective</p> <p>If the switch springs do not function correctly after they are set correctly. Replace the switch springs with new ones.</p> <p>Uncontaminated: Normal Proceed to J 2.</p> <p>Contaminated: Defective Wipe off any foreign matter.</p> <p>Not deformed: Normal Deformed: Defective Correct the bend of the switch terminal.</p>

All procedures of Disassembling, Reassembling, Checking and Adjustment are completed.