

SEIKO

DIGITAL QUARTZ

Cal. A229A

PARTS LIST

Cal. A229A

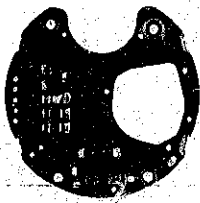
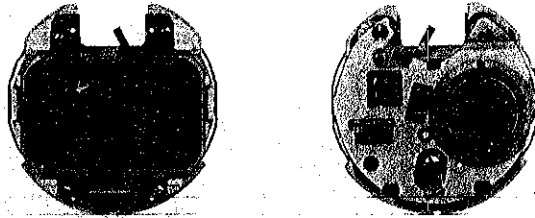

4001 232

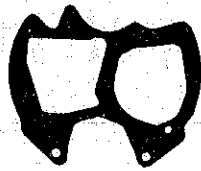

4216 230



4216 231

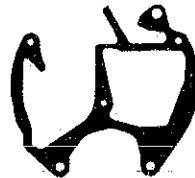

4242 233



4245 230



4245 231



4270 230



4313 230



4313 231

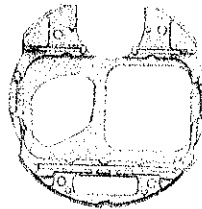

4398 232

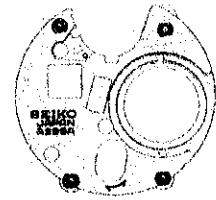

4398 236



☆4510 181

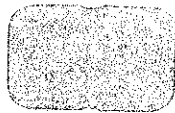

4521 230

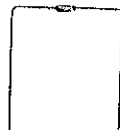

4530 230



4540 230



4540 231



☆Maxell SR926W



012 458



017 144



017 153

2/1

Cal. A229A

Characteristics

Casing diameter: ϕ 28.00 mm
 Maximum height: 4.91 mm without battery
 Frequency of quartz crystal oscillator: 32,768 Hz (Hz=Hertz Cycle per second)
 Time functions: 1 2-hour Digital Display System showing hour, minute and second.
 Calendar functions: Digital Display System showing month, day and date.
 Chronograph functions: Digital Display System showing 1 2-hours, minute and second (or minute, second and 1/100 second up to 20 minutes measurement)
 • Standard stopwatch display: In addition to the standard stopwatch function, lap time and lap time measurement frequency are displayed.
 • Section stopwatch display: In addition to the standard stopwatch function, section lap time and section lap time measurement frequency are displayed.
 Display medium: Nematic Liquid Crystal, FE-Mode
 Time micro adjustor: Trimmer condenser system
 Illuminating light: Illuminates the time and calendar display in the dark.
 Battery life indicator: All the digits in the display begin flashing.

PART NO.	PART NAME	PART NO.	PART NAME
4001 232	Circuit block		
4216 230	Insulator for circuit		
4216 231	Insulator for battery		
4242 233	Plus terminal of battery connection		
4245 230	Switch spring A		
4245 231	Switch spring B		
4270 230	Battery connection		
4313 230	Connector A		
4313 231	Connector B		
4398 232	Liquid crystal panel frame		
4398 236	Battery guard		
☆4510 181	Liquid crystal panel (Silver)		
☆4510 182	Liquid crystal panel (Gold)		
4521 230	Reflecting mirror		
4530 230	Bulb		
4540 230	Liquid crystal panel holder A		
4540 231	Liquid crystal panel holder B		
012 458	Liquid crystal panel holder screw		
017 144	Tube for liquid crystal panel holder screw A		
017 153	Tube for liquid crystal panel holder screw B		
☆ Maxell SR926W	Silver oxide battery		

Remarks:

Liquid crystal panel

☆4510 181 } Be sure that the combination between the color of panel cover and liquid crystal panel should
 ☆4510 182 } be matched according to the "SEIKO Quartz Casing Parts List".

Battery

The applied battery for this calibre might be added the substitutive in the future. In that case, please refer to separate "BATTERIES FOR SEIKO QUARTZ WATCHES".

☆ ⇨ Please see remarks.

Part numbers in light letters are not shown in photos.

TECHNICAL GUIDE

SEIKO DIGITAL QUARTZ

CAL. A229A

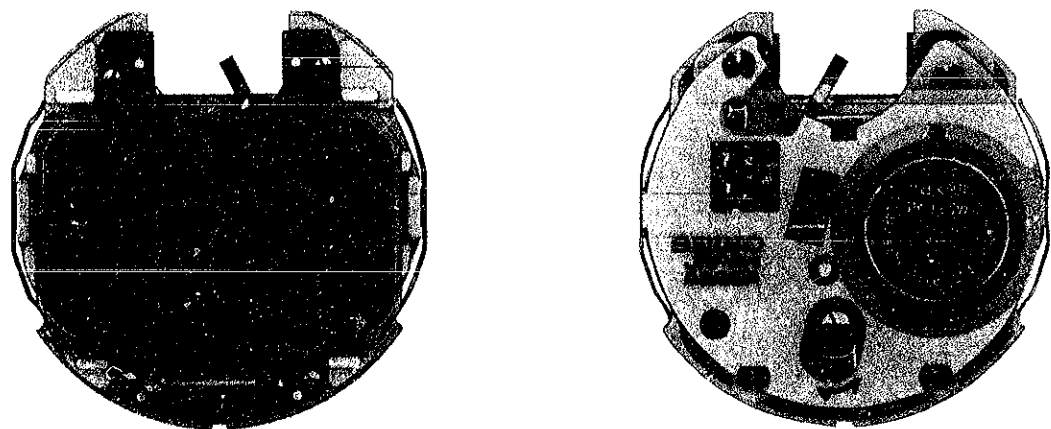

CONTENTS

I. SPECIFICATIONS AND FEATURES	1
1. Specifications	1
2. Features	1
II. DISASSEMBLING AND REASSEMBLING OF THE CASE	2
III. DISASSEMBLING AND REASSEMBLING	4
1. Liquid crystal panel side	4
2. Switch mechanism side	6
IV. CHECKING AND ADJUSTMENT	9
1. Guide table for checking and adjustment	9
2. Relationship between the segment (Liquid Crystal Panel Electrode) and the C-MOS-LSI output terminal	10
3. Procedures for checking and adjustment	11
A : Check battery voltage	11
• Check pattern segment checking system	11
B : Check conductivity of liquid crystal panel, circuit block and connector	11
C : Check circuit block and liquid crystal panel	12
D : Check current consumption	13
E : Check accuracy	13
F : Check functioning and adjustment	14
G : Check bulb condition	14
H : Check conductivity of switch components	14

Calibre A229A

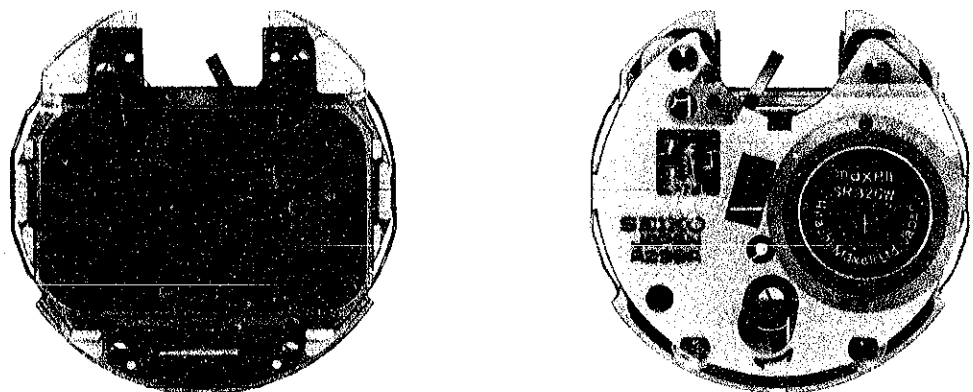

Module

I. SPECIFICATIONS AND FEATURES

1. Specifications

Item	Calibre No. A229A
Display medium	Nematic Liquid Crystal, FEM (Field Effect Mode)
Display system	<p>Time and calendar display</p> <ul style="list-style-type: none"> Hour (12 hour indication), minute, second, month, date, and day of the week are displayed. "A" (AM)/"P" (PM) is displayed only when the hour digit is adjusted. Automatic calendar system automatically adjusts for even and odd months except February of leap years. Day of the week is indicated by the day indicator. <p>Stopwatch display</p> <ul style="list-style-type: none"> Hour, minute and second up to 12 hours (or minute, second, and 1/100 second up to 20 minutes) are displayed in the upper and lower rows. <ul style="list-style-type: none"> (A) Standard stopwatch display: Lap time and lap counter are displayed in addition to the regular stopwatch function. (The minute, second and 1/100 second display automatically shifts to the hour, minute and second display.) <ul style="list-style-type: none"> Standard stopwatch mark LAP and STOP marks LAP counter (B) Section stopwatch display: Section lap time and lap counter are displayed in addition to the regular stopwatch function. <ul style="list-style-type: none"> Section stopwatch mark (Other functions are the same as those for the standard stopwatch display.)
Additional mechanism	Battery life indicator Illuminating light
Crystal oscillator	32,768 Hz (Hz = Hertz . . . Cycle per second)
Loss/gain	Loss/gain at normal temperature range Mean monthly rate : less than 10 seconds (Annual rate : less than 2 minutes)
Casing diameter	φ28.0 mm
Height	4.9 mm without battery
Operational temperature range	-10°C ~ +60°C (14°F ~ 140°F)
Regulation system	Trimmer condenser
Battery power	Silver oxide battery Maxell SR926W Battery life is approximately 2 years. (If the light is used 5 times a day.) Voltage: 1.55V
IC (Integrated Circuit)	C-MOS-LSI 1 unit Transistor 1 unit

2. Features

In addition to the time and calendar function, SEIKO LC Digital Quartz Chronograph Cal. A229A has the stopwatch function as well.

In the stopwatch function, hour, minute and second up to 12 hours or minute, second and 1/100 second up to 20 minutes are displayed in the upper and lower rows. Cal. A229A also displays a lap time in the standard stopwatch function and a section lap time in the section stopwatch function, not to mention a total accumulated time.

II. DISASSEMBLING AND REASSEMBLING OF THE CASE

Disassembling procedures Figs.:

① ~ ⑨

Reassembling procedures Figs.:

⑨ ~ ①

Lubricating:

Silicone grease 500,000 c.s.,
normal quantity

Position for setting the case back

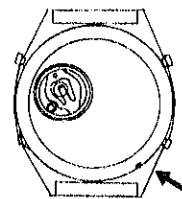

Set the case back in the case bezel so that the notch of the case back lines up to the punch mark on the case bezel.

● Disassembling of the glass and the buttons

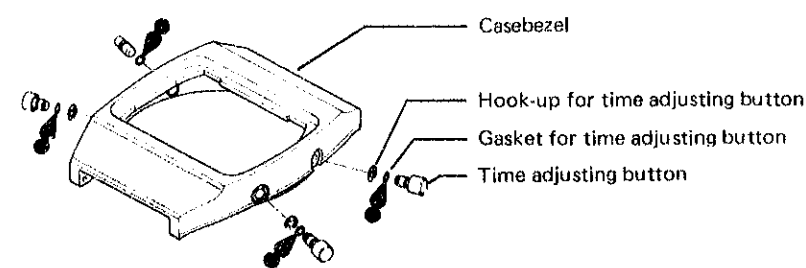
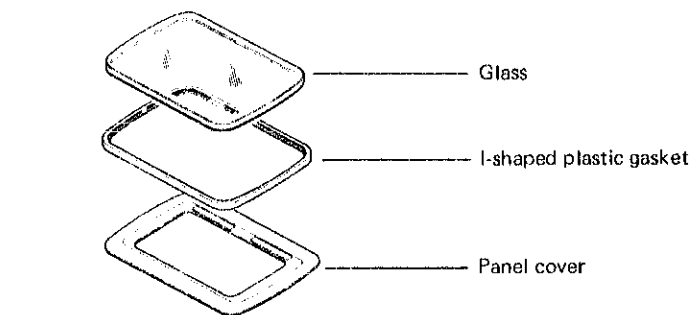

● When the case back is a screw type, set the battery holder on the battery guard. It is not necessary to disassemble except when they are required to be replaced.

It is not necessary to disassemble except when they are required to be replaced. Be sure to lubricate gasket if they are disassembled and before reassembling.

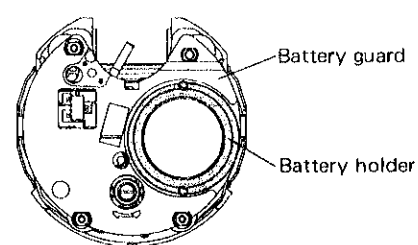
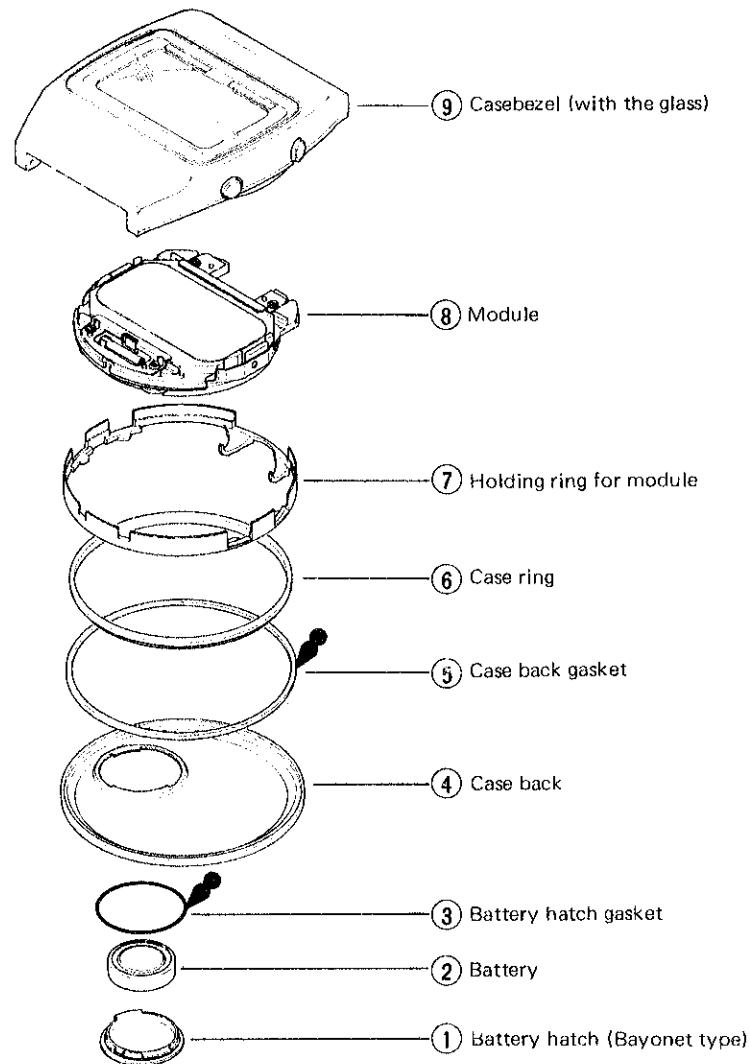

Remarks for disassembling and reassembling

How to replace the glass

● Disassembling of the glass

- With the inserting disk (S-162), push only the glass for disassembling. Do not push the panel cover.
- Select the supporting disk whose diameter is larger than that of the glass.

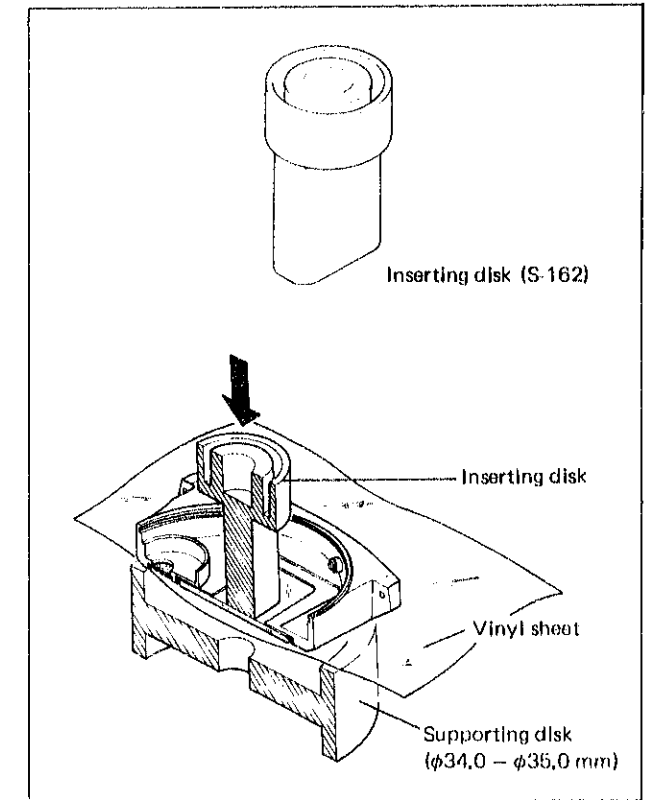
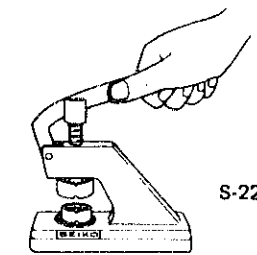

● Reassembling of the glass

- (1) Set the panel cover.
 - Be sure replace it with a new plastic gasket so as to maintain high water resistance.
 - Do not mistake the upper side for the lower side. (See the illustration on the right.)
- (2) Set the glass.
 - Do not mistake the upper side for the lower side. (See the illustration on the right.)
- (3) Set the glass.
 - Do not mistake the upper side for the lower side. (See the illustration on the right.)
- (4) Push the glass.

Inserting disk: Flat disk (S-173)

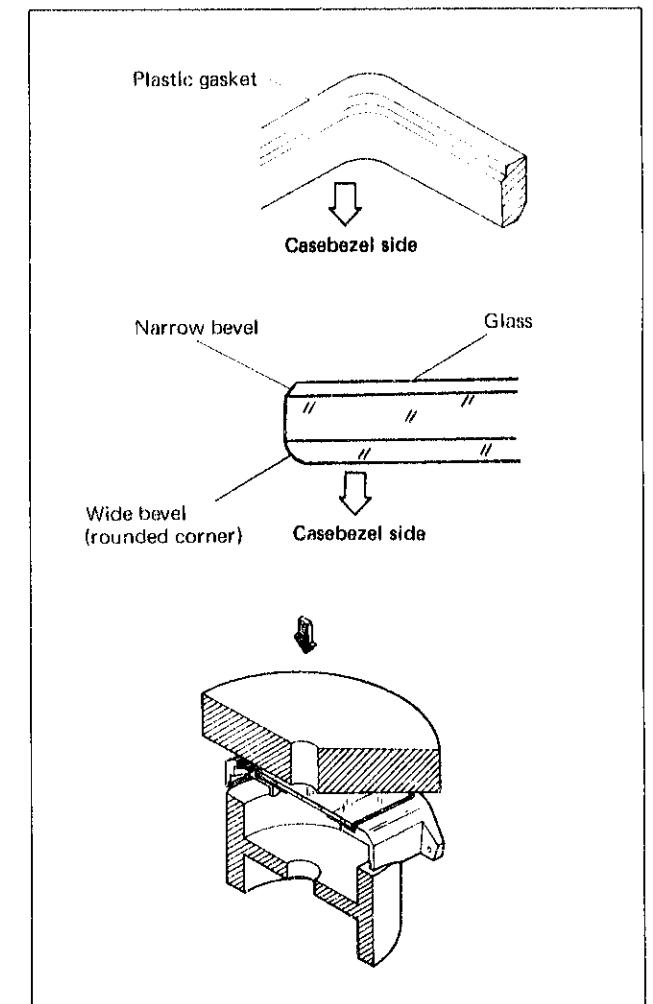

III. DISASSEMBLING AND REASSEMBLING

Disassembling procedures Figs.: ① ~ ⑩

Reassembling procedures Figs.: ⑩ ~ ①

Use the movement holder (S-645).

1. Liquid crystal panel side

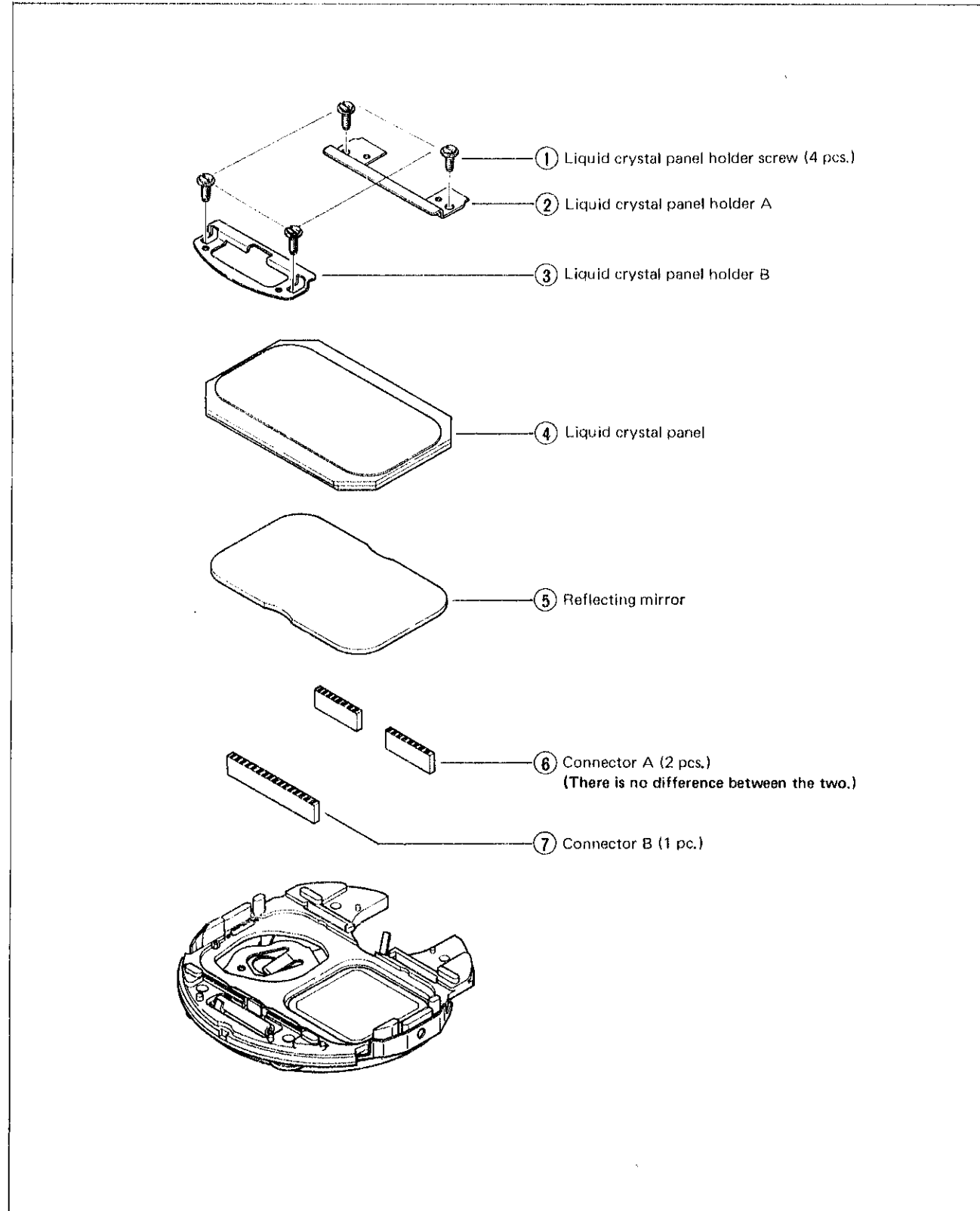

Remarks for disassembling and reassembling

④ Liquid crystal panel

Use fingercots to disassemble and reassemble the liquid crystal panel. Be careful not to push the surface of the liquid crystal panel hard.

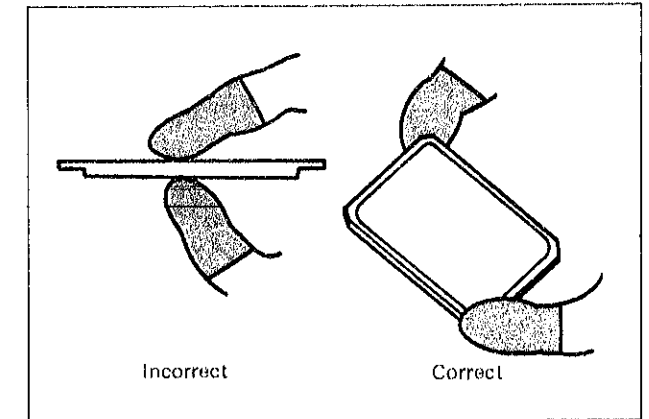

Be sure to set the liquid crystal panel firmly in the liquid crystal panel frame.

Be sure that the liquid crystal panel isn't on the liquid crystal panel holding portion (A) of the liquid crystal panel frame.

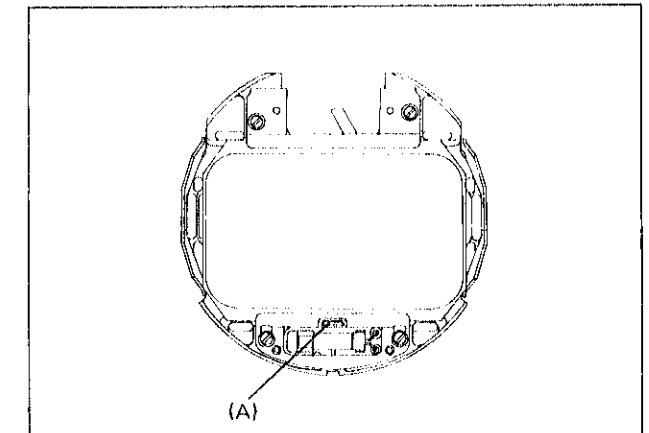

⑤ Reflecting mirror

Use fingercots to disassemble and reassemble the reflecting mirror. Be sure not to use tweezers as they may scratch the surface.

⑥ ⑦ Connectors A and B

Three connectors are used. The black portions are conductive. Check to see if there are any dust, lint, scratches or contamination on the conductive portions.

2. Switch mechanism side

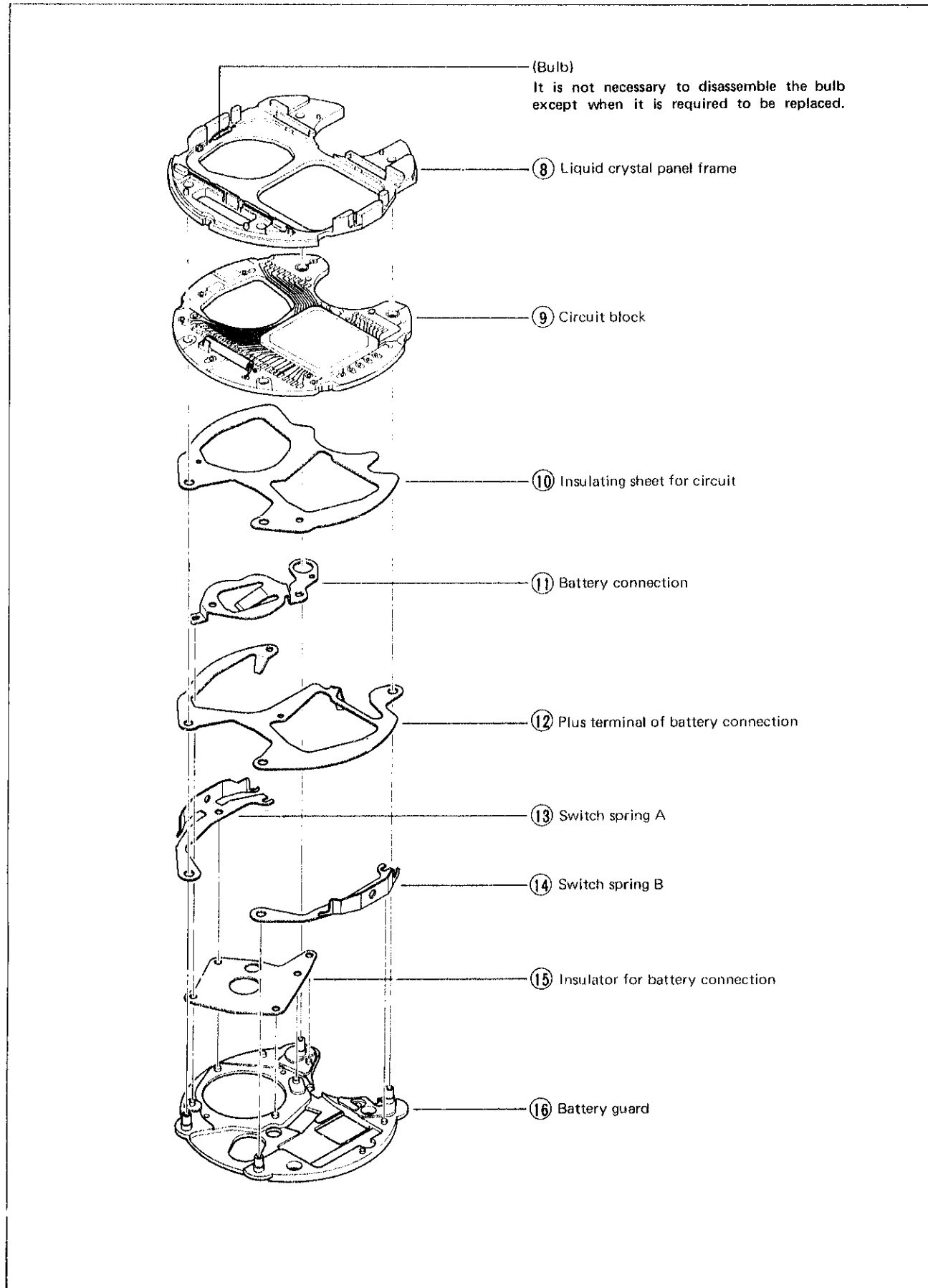

Remarks for disassembling and reassembling

⑧ Liquid crystal panel frame

Be sure to bend the bulb lead wire correctly as shown in the illustration when reassembling the bulb in the liquid crystal panel frame.

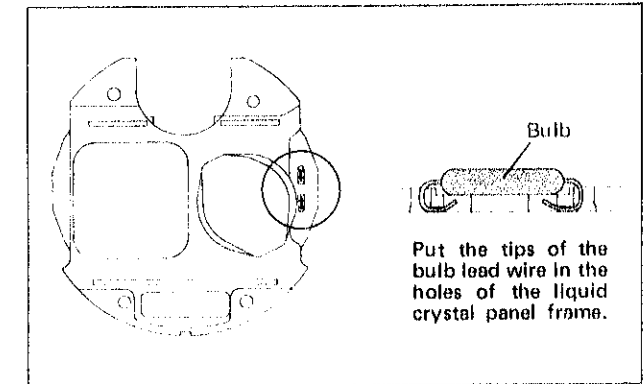

⑫ Plus terminal of battery connection

The plus terminal of the battery connection is so thin that its ground lead terminal is easily bent incorrectly. Be careful not to bend the ground lead incorrectly.

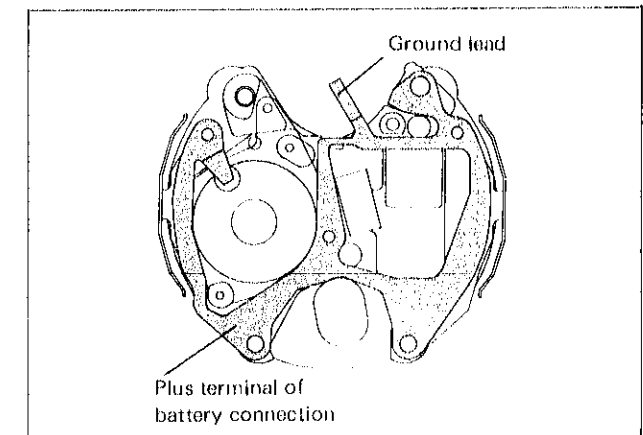

⑬ ⑭ Switch springs A and B

Reassemble the switch springs A and B in the battery guard as shown in the illustration on the right. Be careful not to mistake the front side of the switch spring for the back side. Reassemble so that the switch portion faces the front side.

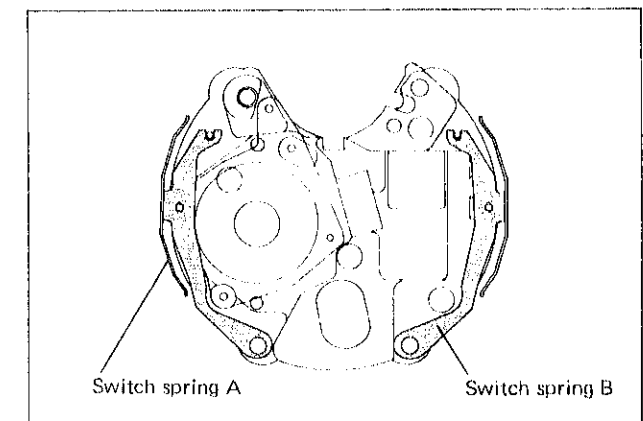

⑮ Insulator for battery connection

Reassemble the insulator for battery connection in the battery guard as shown in the illustration on the right.

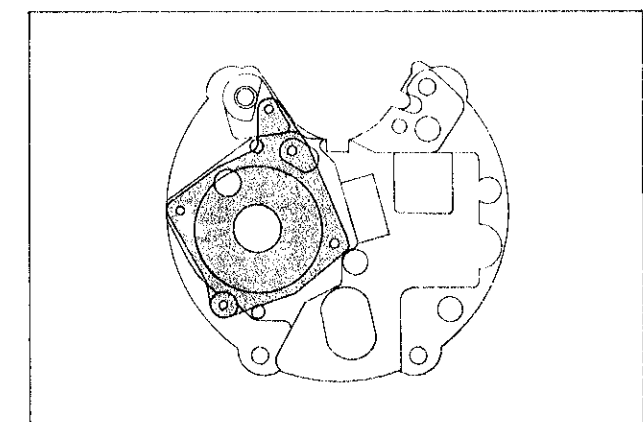

IV. CHECKING AND ADJUSTMENT

1. Guide table for checking and adjustment

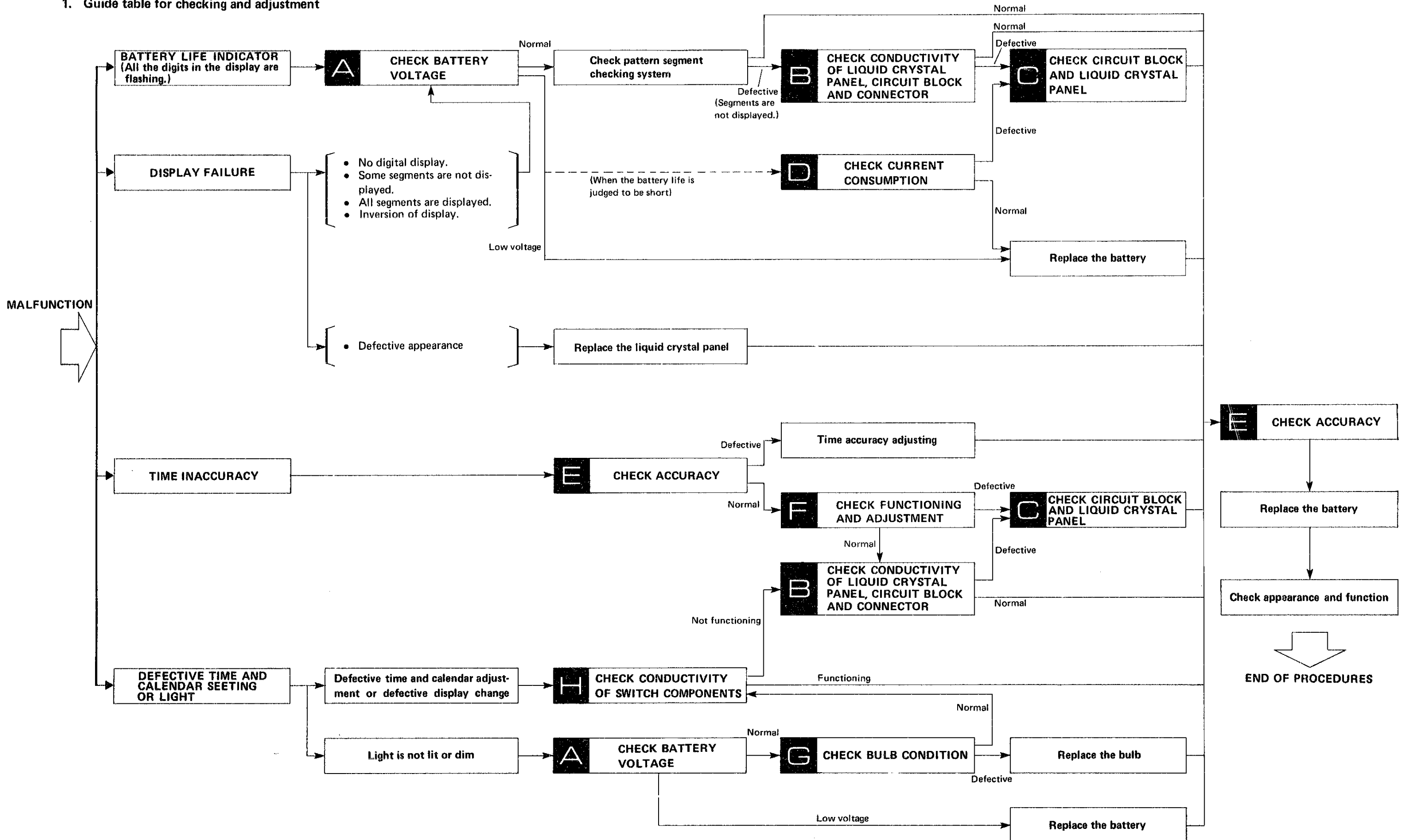

2. Relationship between the segment (Liquid Crystal Panel Electrode) and the CMOS-LSI output terminal

• Designation of segment

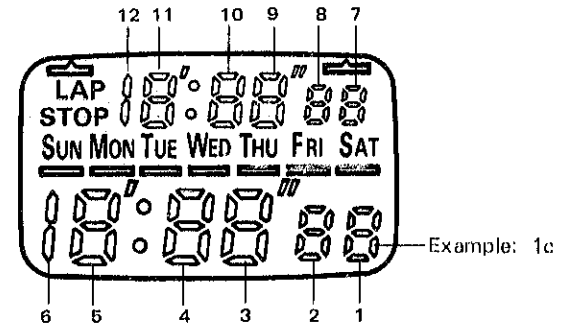
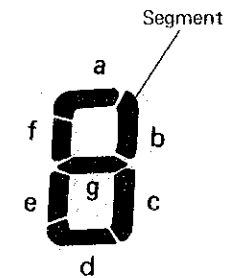

Common electrode (1) corresponds to the segment .



Common electrode (2) corresponds to the segment .

IV. CHECKING AND ADJUSTMENT

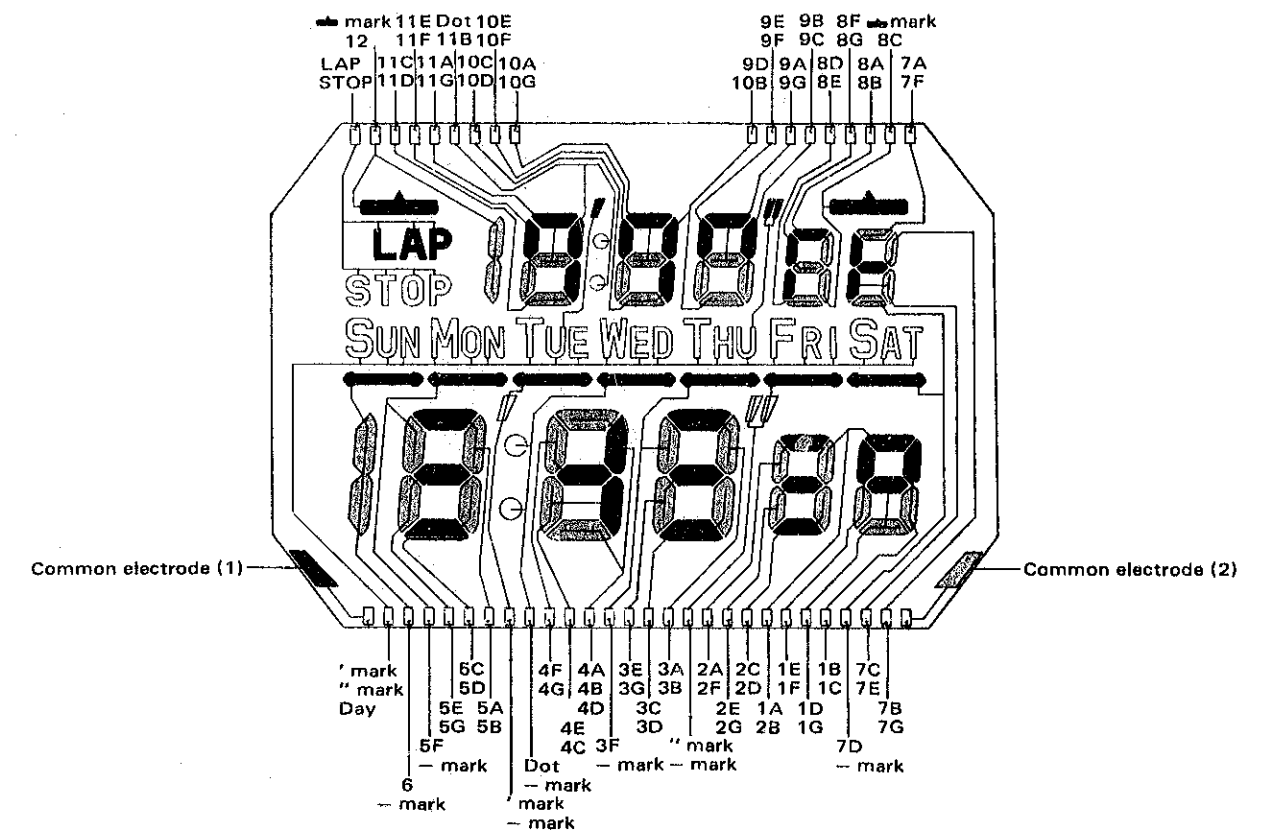
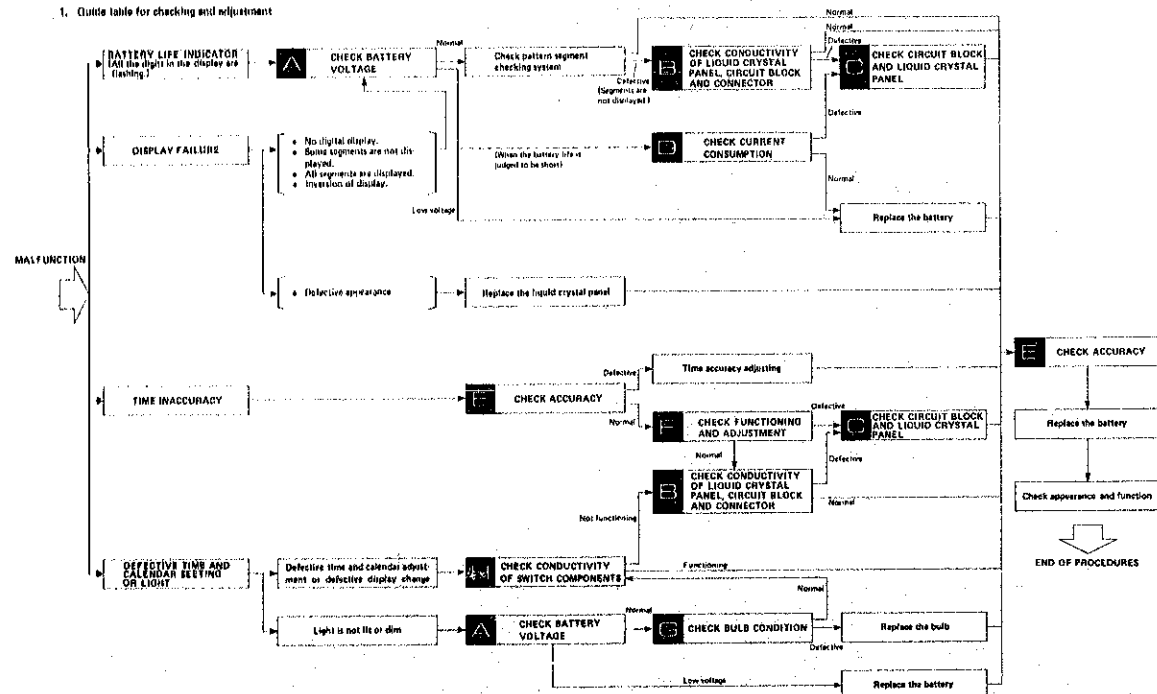
1. Outline table for checking and adjustment

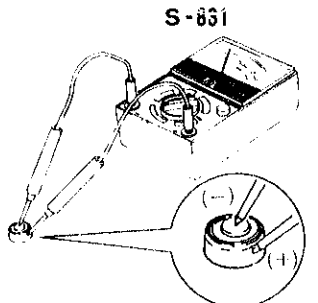

3. Procedures for checking and adjustment

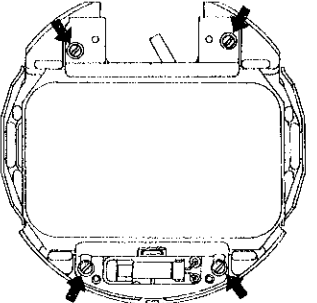
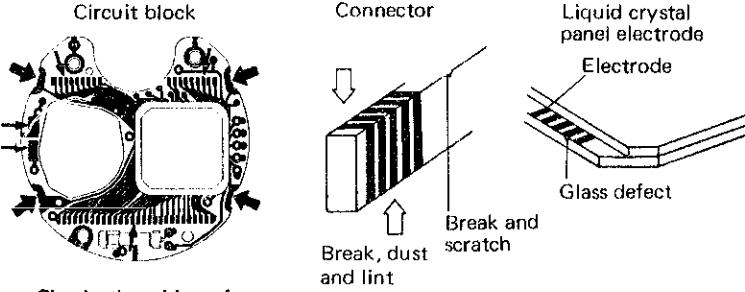
	Procedure	Result and repair
<p>A</p> <p style="writing-mode: vertical-rl; transform: rotate(180deg);">CHECK BATTERY VOLTAGE</p>	<p>Use the following procedures to check battery voltage.</p> <p>(1) Set up the Volt-ohm-meter. Range to be used: DC 3V</p> <p>(2) Measuring Probe Red (+): Battery surface (+) Probe Black (-): Battery surface (-).</p> 	<p>More than 1.5V: Normal Less than 1.5V: Defective Replace the battery.</p>
<p style="writing-mode: vertical-rl; transform: rotate(180deg);">CHECK PATTERN SEGMENT CHECKING SYSTEM</p>	<p>If some segments are dead or dim, change the function into the time function. Then depress and hold the button "B" for 3 to 4 seconds to display all segments. The defective segments will be identified. (Depress and hold the button "B" for 3 to 4 seconds to display all segments, and the daily rate can be measured readily.)</p> 	<p>One segment is not displayed: Proceed to Replace the liquid crystal panel. Two or more segments are not displayed: Proceed to B.</p>
<p>B</p> <p style="writing-mode: vertical-rl; transform: rotate(180deg);">CHECK CONDUCTIVITY OF LIQUID CRYSTAL PANEL, CIRCUIT BLOCK AND CONNECTOR</p>	<p>(1) Make sure that the screws for circuit block are tightened firmly.</p>  <p>(2) Check for dust, lint and other contamination, and break, crack and scratch of the connecting portions.</p>  <p>Check the sides of four switch button portions.</p>	<p>No loosened screws: Normal Proceed to B (2). Loosened screws: Defective Retighten screws.</p> <p>No dust, lint or uncontaminated: Normal Dust lint or contaminated: Defective Wipe off any foreign matter. No break, crack or scratch: Normal Broken, cracked or scratched: Defective Replace with new ones.</p>

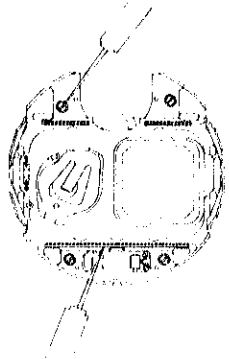
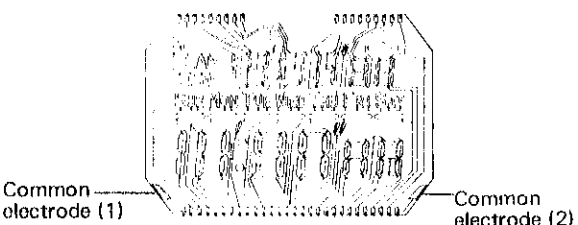
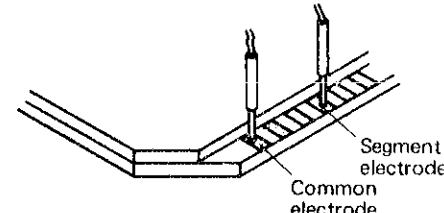
C	Procedure	Result and repair
	<p>(1) Check to see if the electric signal flows into the liquid crystal panel from the circuit block correctly.</p> <ol style="list-style-type: none"> Disassemble the spring for liquid crystal panel and the liquid crystal panel by following the disassembling procedures. Tighten the four liquid crystal panel holder screws. Set the battery in position and fix it by the battery holding spring (S-813). Or use the current supplier (S-833).  <p>Set up the Volt-ohm-meter. Range to be used: DC 3V Probe Red (+): Liquid crystal panel holder screws Probe Black (-): Black portions of the connector (Apply to several portions.)</p>	<p>More than 0.8V: Normal Less than 0.8V: Defective Replace the circuit block.</p>
CHECK CIRCUIT BLOCK AND LIQUID CRYSTAL PANEL	<p>(2) Check for any broken panel pattern, short circuit, etc. of the liquid crystal panel.</p> <ol style="list-style-type: none"> Remove the liquid crystal panel from the module and turn the liquid crystal panel upside down. Set up the Volt-ohm-meter. Range to be used: OHMS R x 1 (Any range will do if more than 3V is applied to the terminal of the Volt-ohm-meter.) Apply one of the two probes to the common electrode of the liquid crystal panel (Either red or black probe will do.) and the other probe to the segment electrode.   <ul style="list-style-type: none"> The liquid crystal panel is provided with two common electrodes. Each segment shows up black by the potential difference between each segment and one of these two common electrodes. For the combination of each segment and common electrodes 1 and 2, see the illustration on page 10. 	<p>Lights up: Normal Does not light up: Defective Replace the liquid crystal panel with a new one.</p>

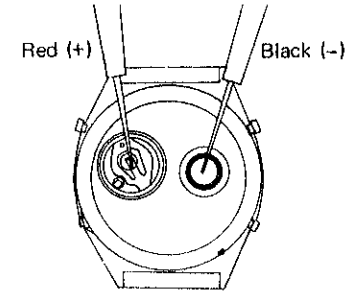
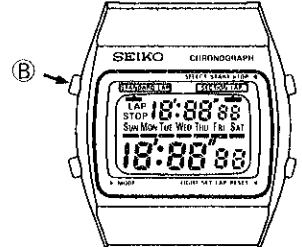
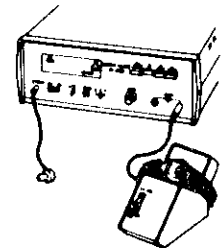
D	Procedure	Result and repair
CHECK CURRENT CONSUMPTION	<p>Check to see if the current consumption is normal.</p> <ol style="list-style-type: none"> Set up the Volt-ohm-meter. Range to be used: DC 12μA Measuring Probe Red (+): Battery connection Probe Black (-): Battery surface (-) The illustration shows how to apply the probes.  <p><i>Note:</i> If the pointer of the Volt-ohm meter swings over the maximum value while the current consumption is measured, change the range to a greater one (Ex. DC 30mA) where the pointer does not run over the maximum value while applying the probes to the respective portions. Then, after two or three seconds, return the range to DC 12μA or 0.03mA again for measuring.</p>	<p>Less than 2.0μA: Normal Replace the battery. More than 2.0μA: Defective Proceed to 13.</p>
CHECK ACCURACY	<p>Check for gain and loss of time.</p> <ol style="list-style-type: none"> Change the function into the time function. Depress and hold button "B" for 3 to 4 seconds to display all segments so that the daily rate can be measured readily.  <ul style="list-style-type: none"> Depress one of the buttons to return to the time function. <ol style="list-style-type: none"> Set up the Quartz Tester. Use the Electric-field detection microphone for quartz crystal watches. 	<p>If the watch tends to gain or lose, proceed to Time accuracy adjusting. Time accuracy is adjusted by turning the trimmer condenser.</p>

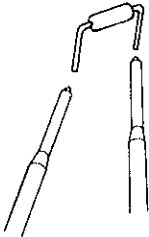
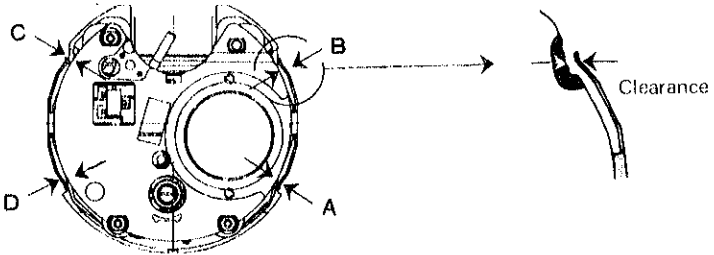
	Procedure	Result and repair
III CHECK FUNCTIONING AND ADJUSTMENT	<p>Check to see if display changeover and adjustment can be made correctly by button operation.</p> <p>(1) Check the adjustment. Check to see if the button operation and the adjustment correspond correctly in all time adjusting functions.</p> <ul style="list-style-type: none"> • Check the watch in all adjusting functions through more than one round of functioning. <p>(2) Check the functioning. Check to see if the time display and the stopwatch display change into each other and function correctly by button operation.</p>	<p>Function correctly and can be adjusted: Normal Proceed to B.</p> <p>Does not function correctly or cannot be adjusted: Defective Replace the circuit block.</p>
G CHECK BULB CONDITION	<p>Check to see if there is a broken filament in the bulb.</p>  <p>(1) Set up the Volt-ohm-meter. Range to be used: OHMS R x 1</p> <p>(2) Measuring Apply red and black probes of the Volt-ohm-meter to the two terminals of the bulb. (Either red or black probe will do.)</p>	<p>Lights up: Normal Does not light up: Defective Replace the bulb with a new one.</p>
I CHECK CONDUCTIVITY OF SWITCH COMPONENTS	<p>Check to see if the switch spring functions correctly.</p> <ul style="list-style-type: none"> • Check with the module reassembled.  <p>(1) Check to see if the portions A, B, C, D of the switch springs touch the electrode of the circuit block when they are pushed in by the tips of tweezers and if, when released, there is a clearance between each switch spring and the electrode of the circuit block, which is about twice the width of the switch spring.</p> <p>(2) Check for dust, lint and other contamination on the contacting portions.</p>	<p>Function correctly: Normal Proceed to H (2).</p> <p>Does not function correctly: Defective If the switch springs do not function correctly after the switch springs are adjusted, replace the switch springs with new ones.</p> <p>No dust, lint or uncontaminated: Normal Dust, lint or contaminated: Defective Wipe off any foreign matter.</p>