















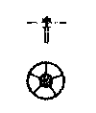















Cal. 2406A

























Characteristics











Casing diameter: 19.00^φ mm
 Maximum height: 4.58 mm
 Vibrations per hour: 28,800
 Automatic and auxiliary hand winding with sweep second
 Calendar (day & date)
 Instant setting device for day & date calendar
 Bilingual change-over system for day of week
 "Diashock" Shock Resistant Device









































Catalog No.

| Calibre No. | Jewels | Style Name | |
|--------------|---|------------|--|
| 2406A | 23j | | |
| PART NO. | LIST OF MATERIALS | PART NO. | LIST OF MATERIALS |
| 112 240 | Barrel & train-wheel bridge | 817 240 | Intermediate date wheel |
| 122 240 | Center wheel bridge | 848 240 | First reverser idler |
| 161 240 | Pallet cock | 851 240 | Second reverser idler |
| 171 240 | Balance cock | 868 240 | Day finger |
| 191 240 | Framework for automatic device | ☆870 166 | Day star with dial disk |
| 201 240 | Complete barrel with arbor & mainspring | ☆870 240 | |
| 224 240 | Center wheel & pinion with cannon pinion | 873 240 | Day jumper |
| 225 240 | Cannon pinion | ☆884 247 | Holding ring for dial |
| 231 240 | Third wheel & pinion | 011 157 | Lower hole jewel for 1st reverser idler |
| 241 240 | Fourth wheel & pinion | 011 157 | Upper hole jewel for 1st reduction wheel |
| 245 240 | Sweep second pinion | 011 157 | Lower hole jewel for 1st reduction wheel |
| 251 240 | Escape wheel & pinion | 011 168 | Lower hole jewel for sweep second pinion |
| 261 240 | Minute wheel | 011 212 | Diashock upper cap jewel |
| 271 240 | Hour wheel | 011 212 | Diashock lower cap jewel |
| 282 240 | Clutch wheel | 011 422 | Upper hole jewel for differential wheel |
| 283 240 | Winding pinion | 011 422 | Lower hole jewel for differential wheel |
| 284 240 | Crown wheel | 011 505 | Upper hole jewel for escape wheel |
| 285 240 | Ratchet wheel | 011 505 | Lower hole jewel for escape wheel |
| 301 110 | Jewelled pallet fork & staff | 011 505 | Upper hole jewel for pallet |
| 310 240 | Balance complete with stud | 011 505 | Lower hole jewel for pallet |
| 315 240 | Balance staff | 011 521 | Upper hole jewel for center wheel |
| 331 110 | Roller with jewel | 011 521 | Lower hole jewel for center wheel |
| 341 240 | Regulator | 011 541 | Upper hole jewel for 4th wheel |
| 345 240 | Stud holder | 011 541 | Lower hole jewel for 4th wheel |
| ☆354 240 | Winding stem | 011 542 | Upper hole jewel for 3rd wheel |
| ☆354 241 | | 011 542 | Lower hole jewel for 3rd wheel |
| ☆354 242 | | 012 123 | Stud screw |
| 372 240 | Joint stem (movement portion) | 012 126 | Center wheel bridge screw |
| 373 250 | Joint stem (case portion) | 012 126 | Minute wheel bridge screw |
| 381 240 | Click | 012 133 | Friction spring screw for sweep second pinion |
| 382 030 | Click spring | 012 275 | Bridge screw |
| ☆383 240 | Setting lever | 012 275 | Balance cock screw |
| ☆383 241 | | 012 275 | Framework screw for automatic device |
| ☆383 242 | | 012 297 | Crown wheel screw |
| ☆383 243 | | 012 421 | Transmission wheel screw |
| 384 240 | Yoke (Clutch lever) | 012 762 | Dial screw |
| 387 240 | Minute wheel bridge | 012 763 | Pallet cock screw |
| 388 240 | Setting lever spring | 012 764 | Casing clamp screw |
| 390 240 | Setting lever axle | 012 767 | Setting lever spring screw |
| 396 240 | Friction spring for sweep second pinion | 012 767 | Day jumper screw |
| 399 003 | Casing clamp | 012 767 | Date driving wheel screw |
| 464 240 | Holding ring for setting wheel lever complete | 012 767 | Screw for setting wheel lever complete |
| 481 240 | Crown wheel ring | 013 064 | Tube for screw of setting wheel lever complete |
| 491 180 | Dial washer | 013 065 | Tube for yoke |
| 493 070 | Hour wheel ring | | (Tube for barrel & train-wheel bridge screw) |
| 499 240 | Day finger ring | 013 834 | Click pin |
| 505 240 | Transmission wheel | 013 836 | Second reduction wheel pin |
| 509 240 | Oscillating weight with ball-bearing | 013 837 | Date dial guard pin |
| 511 240 | First reduction wheel | 014 413 | Diashock upper frame |
| 514 240 | Second reduction wheel | 014 414 | Diashock lower frame |
| 531 240 | Differential wheel | 014 415 | Diashock hole jewel with frame |
| 556 240 | Date finger | 014 417 | Diashock spring |
| ☆801 240 | Date dial | | |
| ☆801 244 | | | |
| 802 240 | Date driving wheel | | |
| 803 240 | Setting wheel lever complete | | |
| 808 240 | Date dial guard | | |
| 810 240 | Date jumper | | |

☆⇨ Please see remarks on the next page.
 Items in light letters are not shown in photos.

| | | |
|-----------------------------|----------------------|------------|
| Calibre No. 2406A | Jewels 23j | Style Name |
|-----------------------------|----------------------|------------|

Remarks :

Winding stem — There are three types of winding stems. Select a suitable one by referring to the photographs on the front page and the shapes in the lower diagram.

- ☆354 240..... a size is **1.26 mm** and thread is provided completely on the crown portion.
- ☆354 241..... a size is **3.80 mm** and thread is provided only on the end of the crown portion.
- ☆354 242..... a size is **1.26 mm** and thread is provided only on the end of the crown portion.

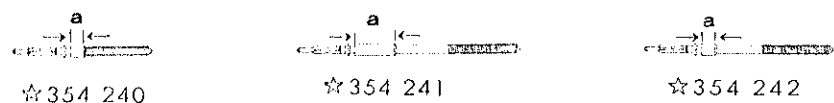

Setting lever

There are four types of setting levers. They are used according to the shapes of dial, structures of case and types of winding stem. Select a suitable one by the following procedures referring to the shapes indicated in Fig. 1.

☆383 240..... Used for watch with joint stem, or with ordinary winding stem other than one-piece or square-type water-resistant case.

☆383 241 }
 ☆383 242 } ... Those setting levers are used for one-piece or square-type water-resistant case with ordinary winding stem. Select the setting lever whose tail can be set between the dial and the case as shown Fig. 2 when assembling the movement in the case by referring to the shapes in Fig. 1. If an incorrect setting lever for dial diameter is used, the winding stem can not be pulled out or the movement can not be set in the case. Attention must be paid to this point.

When part number of the setting lever is unknown, specify ① Cal. No. ② jewels ③ dial No. and ④ case No.

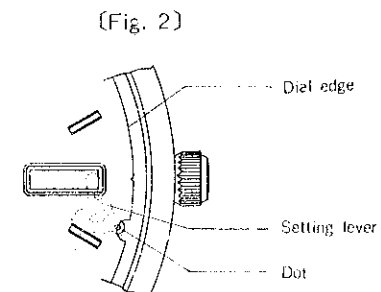
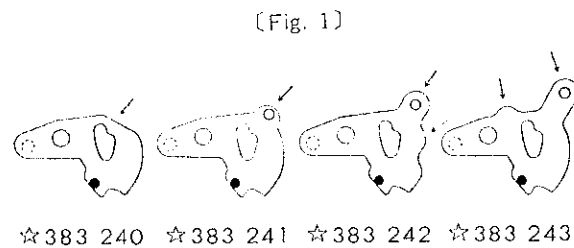

(Example of suitable setting lever)
 Tail of the setting lever is located between the dial and the case.

Date dial

- ☆801 240.....Used when both the crown and the date frame are located at **3 o'clock** position.
- ☆801 244.....Used when the crown is located at **3 o'clock** position and the date frame at **6 o'clock** position.

If the date dial is required in any other type, specify ① Cal. No. ② jewels ③ the crown position ④ the date frame position and ⑤ dial No.

Day star with dial disk

- ☆870 166(English ↔ Japanese)Used when the crown is located at **3 o'clock** position and the day frame at **6 o'clock** position.
- ☆870 240(English ↔ Japanese)Used when both the crown and the day frame are located at **3 o'clock** position.

If the day star with dial disk is required in any other type, specify the number printed on the disk.

— continued on reverse page —

| | | |
|-----------------------------|----------------------|------------|
| Calibre No. 2406A | Jewels 23j | Style Name |
|-----------------------------|----------------------|------------|

Remarks : — continued —

Holding ring for dial — The holding ring for dial differs according to the design of the dial. Select the suitable one by the following procedures.

☆884 247.....Refer to the photograph on the front page and Fig. 1.

When ordering the other part than the above, specify the part number printed in the **12 o'clock** direction of the dial.

If the part number of the holding ring for dial is unknown, specify ① Cal. No. ② jewels ③ dial No. and ④ case No.

(Fig. 1)

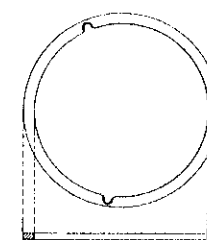

☆884 247

(Fig. 2)

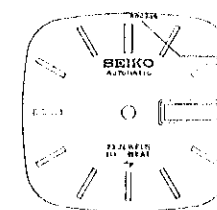

The part number of the holding ring for dial to be used for this dial.

2406A (2409, 2415, 2418 derived from this calibre)

2406A Calendar and Setting Mechanisms

(1) Specifications

Casing diameter 19.00mm
 Height 4.58mm
 Vibrations per hour 28,800

(8 beats per second)

Automatic winding (with auxiliary hand winding mechanism)

Setting wheel lever system

Calendar (day, date, Bilingual change-over mechanism for day indication and Instant day and date setting mechanism)

(2) Features

Thin and dress type automatic, multifunctional winding watch

Movement size is designed in two types for Ladies' and Gents' watch as 24 series calibres list below.

High-Vibration watch with stabilized time accuracy

By adopting a high-vibration mechanism (8 beats), exceptional timing accuracy is maintained. Winding capacity, which is the life of the automatic winding watch, has been ingeniously devised, creating a reliable timepiece.

Simple day & date setting mechanism

The day and date setting mechanism is also compactly designed around the second setting lever. This makes it extremely easy to disassemble and assemble the parts, and the regularity of the day and date mechanism maintained with steadiness.

(3) Disassembling and Assembling

Disassemble watch as in Fig. ① → ⑤⑨

Assemble watch as in Fig. ⑤⑨ → ①

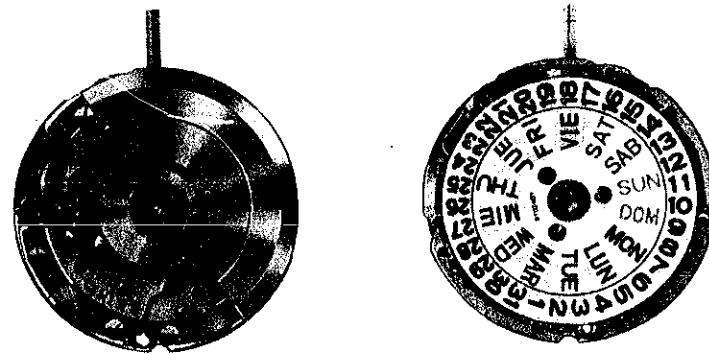

MOVEMENT

(4) Lubrication

The following symbols in the illustrated figures indicate the types of oil, the quantities to be applied, and the lubricating points.

Types of oil

- SEIKO watch oil S-6
- SEIKO watch oil S-4
- SEIKO watch oil S-3
- Moebius synt-A-Lube
- Moebius synt-V-Lube

Oil quantity

- : Extremely small quantity
- : Normal quantity
- : Sufficient quantity

24 SERIES CALIBRES AND THEIR FEATURES

| Calibre No. | Casing diameter (mm) | Height (mm) | Train wheel Mechanism | | Calendar | | | Day date correcting | |
|-------------|----------------------|-------------|-----------------------|--------------|----------|-----|---------------------------------|---------------------|----------------|
| | | | hour & minute hands | Sweep second | Date | Day | Bilingual change-over mechanism | Date correcting | Day correcting |
| 2406 | 19.0 | 4.5 | | o | o | o | o | o | o |
| 2415 | 19.0 | 4.5 | o | | o | | | o | |
| 2409 | 24.0 | 4.5 | | o | o | o | o | o | o |
| 2418 | 24.0 | 4.5 | o | | o | | | o | |

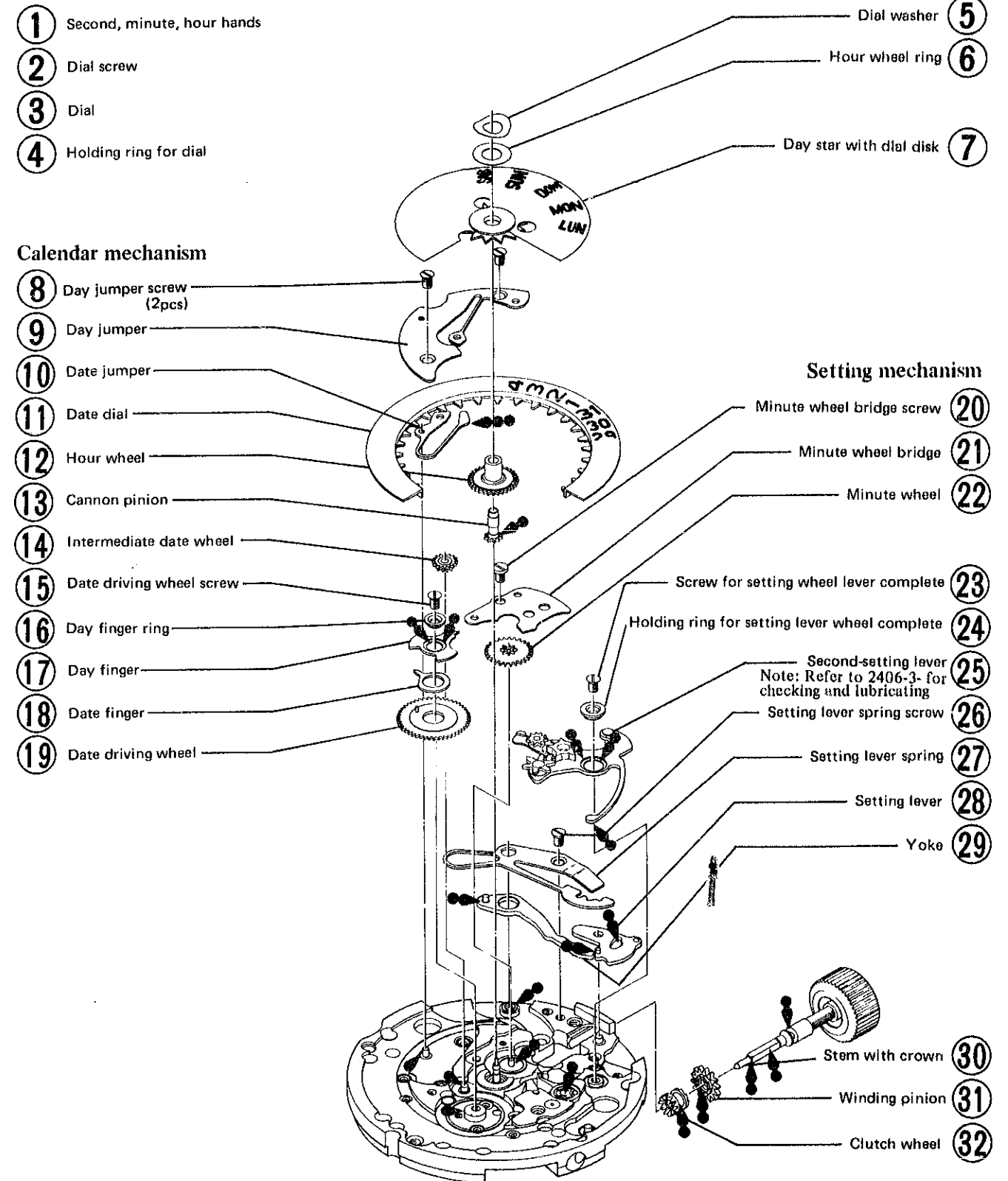

2406A Automatic winding, Train wheel, Escapement and Governor Mechanisms

Notes on disassembling and assembling

How to remove hands

Since the dial is thin and easy to bend, use a bow-type hand remover when detaching hands.



Dial washer

The bending should be 20/100 - 40/100mm (0.7 - 1.5 times thickness of dial)

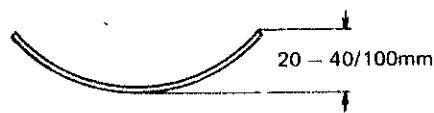

Hour wheel ring

This is used when shake of hour wheel (day star with dial disk) is more than 8/100mm. (When shaking is more than 1/4 dial thickness or thickness of day star with dial disk).

Yoke spring (Clutch lever spring)

Set yoke spring at position shown in diagram. When removing setting lever spring screw, be careful the screw will not spring out.

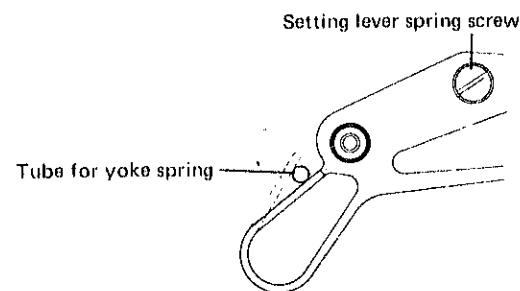

Pushing in cannon pinion

Push in cannon pinion after assembling barrel and train wheel bridge to prevent shake of center wheel and pinion from becoming excessive.

Assembling day finger and date finger

When assembling day finger, carefully note position of date driving wheel pin. Assemble date finger by placing bent surface upward.

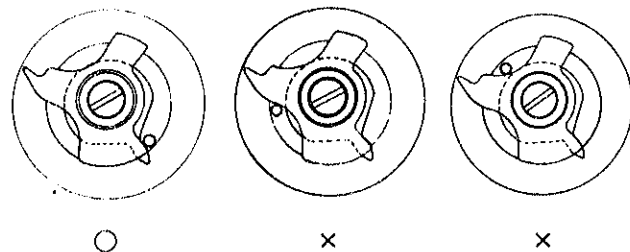

Checking on second-setting lever

1) Structure of second-setting lever

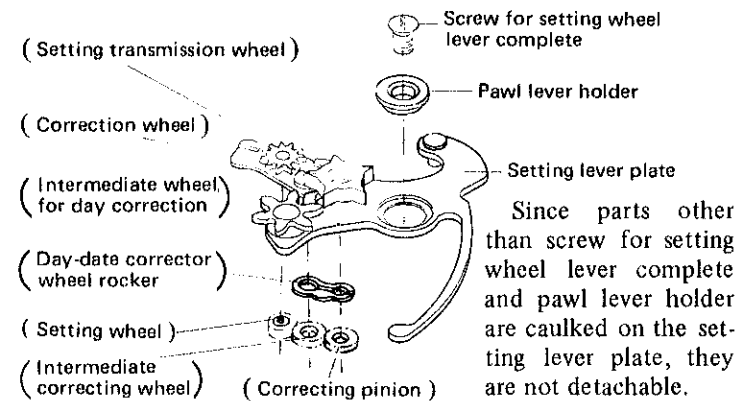

2) Lubricating points on second-setting lever

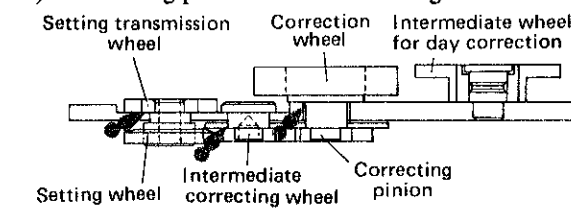

Apply oil from clearances between Second setting lever complete and Intermediate correcting wheel, Correcting pinion and Setting wheel.

3) Checking performance of day-date corrector wheel rocker

Before assembling second-setting lever, check day-date corrector wheel rocker to note whether or not it moves smoothly along the long hole when correction wheel is moved with a small brush or a pair of tweezers.

Note) If excessive oil is applied to day-date corrector wheel rocker, motion of day-date corrector wheel rocker will become defective due to adhesion of second-setting lever complete and day-date corrector wheel rocker.

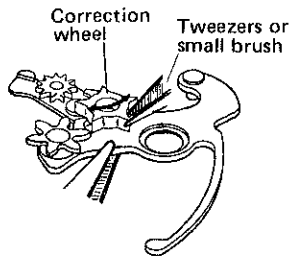

4) Precautions on assembling second-setting lever to plate

After setting second-setting lever pin in hole of setting lever and tightening screw for setting wheel lever complete, set second-setting lever by bending its tail portion in direction of arrow.

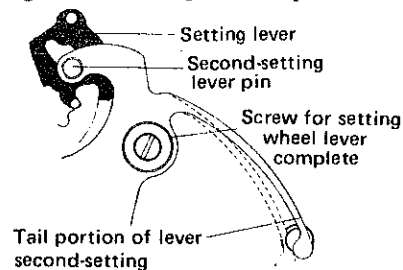

Oscillating weight

- 1) Since groove of the oscillating weight screw has a curve, use a driver as shown on the right.
- 2) Be careful in pressing the oscillating weight screw here, since if forcibly pressed, the bearing axle may come off.

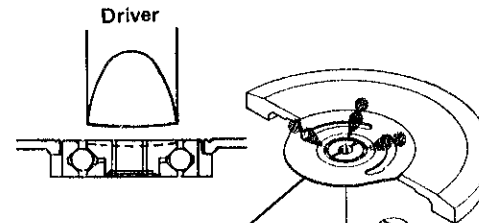

Automatic winding mechanism

- 33 Oscillating weight
- 34 Framework screw for automatic device (2pcs)
- 35 Framework for automatic device
- 36 Differential wheel
- 37 First reduction wheel
- 38 Crown wheel screw
- 39 Crown wheel ring
- 40 Crown wheel
- 41 Barrel & train-wheel bridge screw (4 pcs)
- 42 Barrel & train-wheel bridge
- Do not detach transmission wheel and first reverser idler (If you have to disassemble, refer to the next page)
- (Second reduction wheel) When lubricating, refer to the next page.

Train wheel mechanism

- 43 Third wheel & pinion
- 44 Sweep second wheel & pinion
- 45 Escape wheel
- 46 Friction spring screw for sweep second pinion
- 47 Friction spring for sweep second pinion
- 48 Sweep second pinion

Escapement and Governor mechanism

- 55 Balance cock screw
- 56 Balance Complete
- 57 Pallet cock screw
- 58 Pallet cock
- 59 Pallet
- 49 Center wheel bridge screw
- 50 Center wheel bridge
- 51 Second reverser idler
- 52 Center wheel and pinion with cannon pinion
- 53 Ratchet wheel
- 54 Complete barrel with arbor

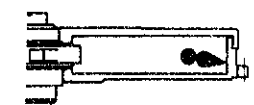

It is unnecessary to disassemble the complete barrel with arbor. When it is disassembled and washed inadvertently, use the SEIKO oil S-3.

2406A Setting Mechanism

Note on disassembling and assembling

Assembling crown wheel and ratchet wheel

When assembling the crown wheel and the ratchet wheel, do not mistake their front with rear surfaces.

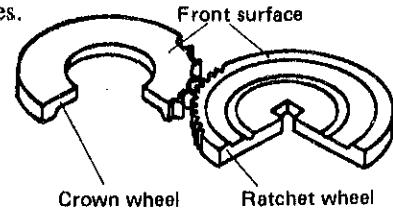

Framework for automatic device

Since the second reduction wheel is caulked on the framework for automatic device, they are not detachable from each other.

Apply oil from this crescent-shaped groove of second reduction wheel pin.

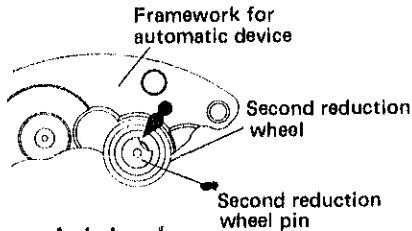

Lubricating Third wheel lower hole jewel

Since clearance between third wheel lower hole jewel and center wheel and pinion with cannon pinion is small, apply oil only in small quantity to third wheel lower hole jewel.

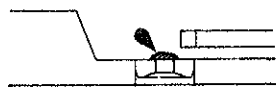

Disassembling Transmission wheel and First reverser idler

Do not detach transmission wheel and first reverser idler as they are difficult to assemble. Wash them together as they are, with the barrel and train wheel bridge.

If you have to disassemble, first place barrel and train wheel bridge on the reverting stake; and then insert first reverser idler in the hole of the reverting stake. Next, take them apart by loosening transmission wheel screw after inserting the tip of the screw-driver into the clearance between the teeth of transmission wheel and stopping its revolution.

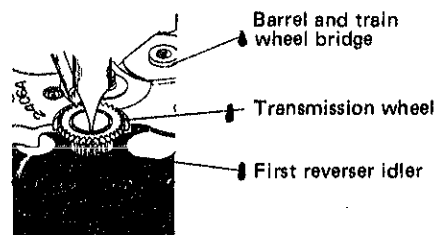

Lubrication

Lubricate them through clearance between barrel & train wheel bridge and first reverser idler.

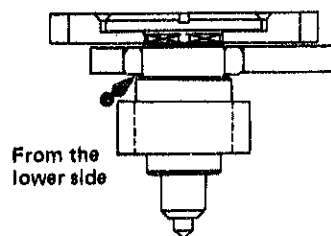

Checking on locking and smooth idling of differential wheel

1) Checking on differential wheel

Using a small brush or soft material, confirm locking and smooth idling for both the upper and lower wheels before assembling differential wheel.

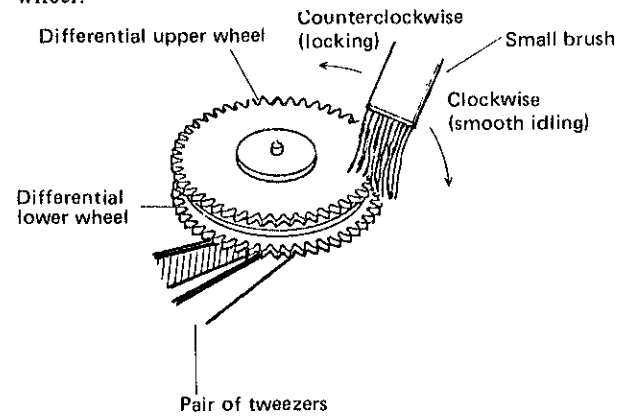

Facing the pinion lower side . . .
Clockwise . . . Revolves smoothly (SMOOTH IDLING)

Counterclockwise . . . Stops after moving slightly (LOCKING)

2) Checking on the differential wheel with oscillating weight smooth idling

Should oscillating weight revolve over 180° after the crown is wound 5 revolutions and released by 2.5 revolutions, this is a sign that some wheel motion is not functioning properly.

Check the following if this happens.

- o Check on malfunction of the differential wheel
- o Check if there is an insufficiency of shake in sections of automatic winding and train wheel

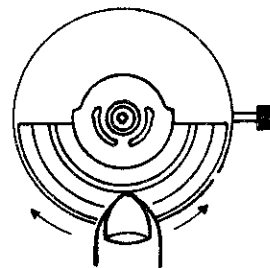

Checking on fault in locking

Turn differential wheel by moving oscillating weight clockwise and counterclockwise each 90° ten times alternately. At this time, should oscillating weight reverse over 45°, this indicates a malfunction in locking.

Clean differential wheel with benzine or S-clean.

It is not necessary to lubricate inside differential wheel which is self-greasing.

Normal position of crown (winding the mainspring)

In the position with winding pinion and clutch wheel interlocked, the mainspring is wound manually. (Fig. 1)

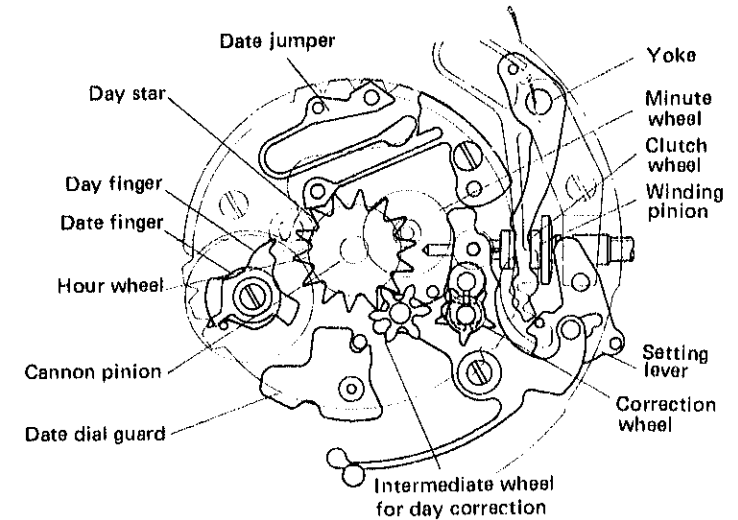

Fig. 1

First click of crown (correction of day and date)

When clutch wheel and setting wheel are interlocked, and crown is rotated clockwise, day-date corrector wheel rocker moves toward day star with dial disk side, and permits day setting. (Fig. 2)

When crown is rotated counterclockwise, day-date corrector wheel rocker moves towards date dial, allowing date adjustment.

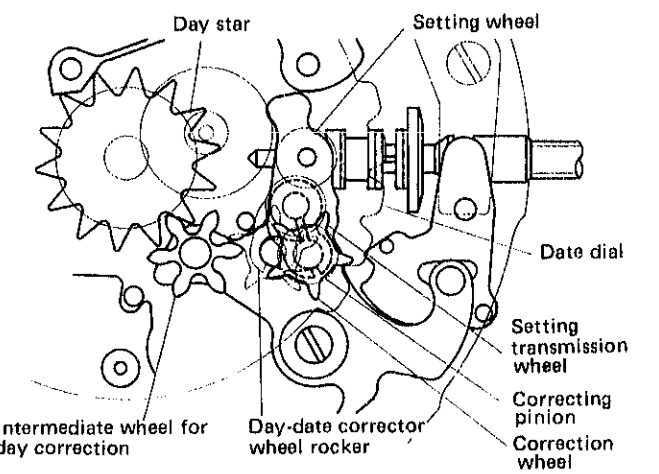
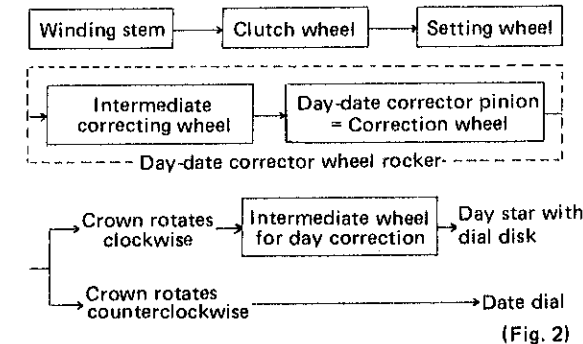

Fig. 2

Second click of crown (setting time)

The second setting lever moves, pressed by setting lever and setting transmission wheel attached to setting wheel lever complete and interlocks with minute wheel. In this position, setting by hand is possible when crown is revolved. (Fig. 3)

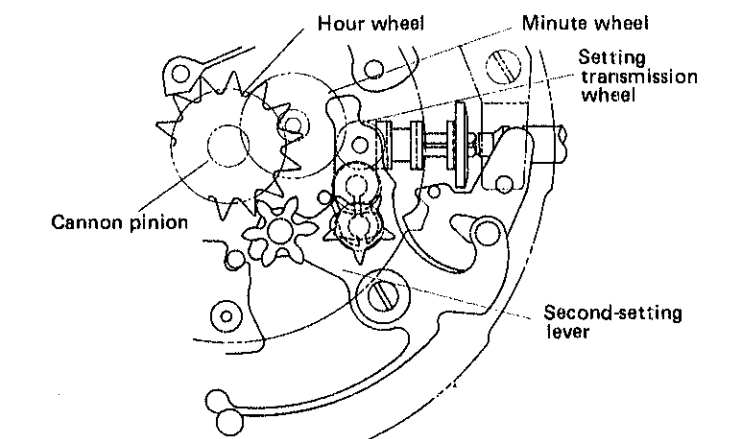
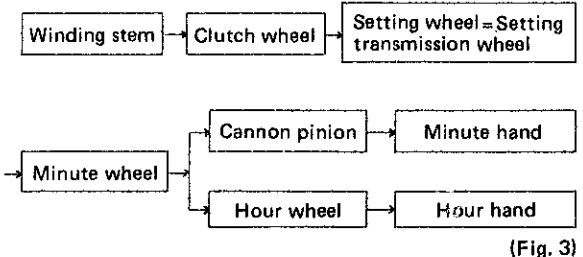

Fig. 3